

TECHNICAL MANUAL
Of
Intel 945GC +Intel 82801G
Based
Mini-ITX M/B For Intel Atom Processor

NO.G03-NC92-F

Rev1.0

Release date: Oct., 2008

Trademark:

* Specifications and Information contained in this documentation are furnished for information use only, and are subject to change at any time without notice, and should not be construed as a commitment by manufacturer.

Environmental Protection Announcement

Do not dispose this electronic device into the trash while discarding. To minimize pollution and ensure environment protection of mother earth, please recycle.



TABLE OF CONTENT

USER'S NOTICE	iv
MANUAL REVISION INFORMATION	iv
ITEM CHECKLIST	iv
CHAPTER 1 INTRODUCTION OF THE MOTHERBOARD	
1-1 FEATURE OF MOTHERBOARD	1
1-2 SPECIFICATION.....	2
1-3 LAYOUT DIAGRAM	3
CHAPTER 2 JUMPER SETTING, CONNECTORS AND HEADERS	
2-1 JUMPER SETTING	6
2-2 CONNECTORS AND HEADERS	7
2-2-1 CONNECTORS.....	7
2-2-2 HEADERS	9
CHAPTER 3 INTRODUCING BIOS	
3-1 ENTERING SETUP.....	14
3-2 GETTING HELP.....	15
3-3 THE MAIN MENU.....	15
3-4 STANDARD CMOS FEATURES.....	17
3-5 ADVANCED BIOS FEATURES.....	19
3-6 ADVANCED CHIPSET FEATURES.....	21
3-7 INTERGRATED PERIPHERALS.....	23
3-7-1 ONBOARD IDE FUNCTION.....	24
3-7-2 ONBOARD DEVICE FUNCTION.....	25
3-7-3 ONBOARD SUPER IO FUNCTION.....	26
3-8 POWER MANAGERMENT SETUP.....	27
3-9 PNP/PCI CONFIGURATIONS.....	30
3-10 PC HEALTH STATUS.....	30
3-11 MISCELLANEOUS CONTROL.....	32
3-12 PASSWORD SETTING.....	33
3-13 LOAD SATANDARD/OPTIMIZED DEFAULTS.....	34

USER'S NOTICE

COPYRIGHT OF THIS MANUAL BELONGS TO THE MANUFACTURER. NO PART OF THIS MANUAL, INCLUDING THE PRODUCTS AND SOFTWARE DESCRIBED IN IT MAY BE REPRODUCED, TRANSMITTED OR TRANSLATED INTO ANY LANGUAGE IN ANY FORM OR BY ANY MEANS WITHOUT WRITTEN PERMISSION OF THE MANUFACTURER.

THIS MANUAL CONTAINS ALL INFORMATION REQUIRED TO USE INTEL 945GM CHIPSET MOTHER-BOARD SERIES AND WE DO ASSURE THIS MANUAL MEETS USER'S REQUIREMENT BUT WILL CHANGE, CORRECT ANY TIME WITHOUT NOTICE. MANUFACTURER PROVIDES THIS MANUAL "AS IS" WITHOUT WARRANTY OF ANY KIND, AND WILL NOT BE LIABLE FOR ANY INDIRECT, SPECIAL, INCIDENTAL OR CONSEQUENTIAL DAMAGES (INCLUDING DAMAGES FOR LOSS OF PROFIT, LOSS OF BUSINESS, LOSS OF USE OF DATA, INTERRUPTION OF BUSINESS AND THE LIKE).

PRODUCTS AND CORPORATE NAMES APPEARING IN THIS MANUAL MAY OR MAY NOT BE REGISTERED TRADEMARKS OR COPYRIGHTS OF THEIR RESPECTIVE COMPANIES, AND THEY ARE USED ONLY FOR IDENTIFICATION OR EXPLANATION AND TO THE OWNER'S BENEFIT, WITHOUT INTENT TO INFRINGE.

Manual Revision Information

Reversion	Revision History	Date
1.0	First Edition	Oct., 2008

Item Checklist

- Motherboard
- Cable(s)
- CD for motherboard utilities
- Motherboard User's Manual
- I/O Back panel Shield

Chapter 1

Introduction of the Motherboard

1-1 Feature of motherboard

- * Intel 945GC Northbridge and Intel 82801G (ICH7) Southbridge chipset.
- * **Onboard Intel Atom CPU**, with low power consumption never denies high performance.
- * Support FSB 533 MHz.
- * Support DDRII 400/533 MHz up to 2GB.
- * Onboard Realtek RTL 8111C Gigabit Ethernet LAN.
- * Integrated Realtek ALC662 6-channel HD audio CODEC.
- * Support USB2.0 data transport demands.

1-2 Specification

Spec	Description
Design	* Mini ITX form factor 6 layers PCB size: 17.0x17.0cm
Chipset	* Intel 945GC Northbridge chipset * Intel 82801G(ICH7) Southbridge chipset
Embedded CPU	* Intel Atom CPU * Support FSB 533 * Low Power Consumption
Memory Socket	* 240-pin DDRII DIMM socket x1 * Support DDRII 400/533MHz system Modules DDRII memory * Expandable to 2GB.
Expansion Slot	* 32-bit PCI slot x 1pcs
Integrate IDE	* One PCI IDE controller that supports PCI Bus Mastering, ATA PIO/DMA and the ULTRA DMA 100/66 functions that deliver the data transfer rate up to 100 MB/s;
LAN	* Integrated Realtek RTL8111C PCI-E Gigabit LAN chip. * Support Fast Ethernet LAN function of providing 10Mb/100Mb/1000Mb Ethernet data transfer rate
Audio	* Realtek ALC662 6 channel Audio Codec integrated * Audio driver and utility included
BIOS	* Award 8MB Flash ROM

1-3 Layout Diagram

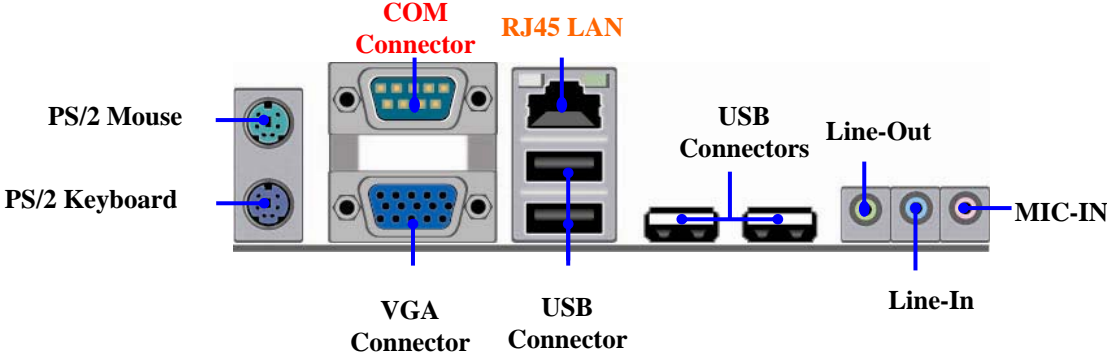

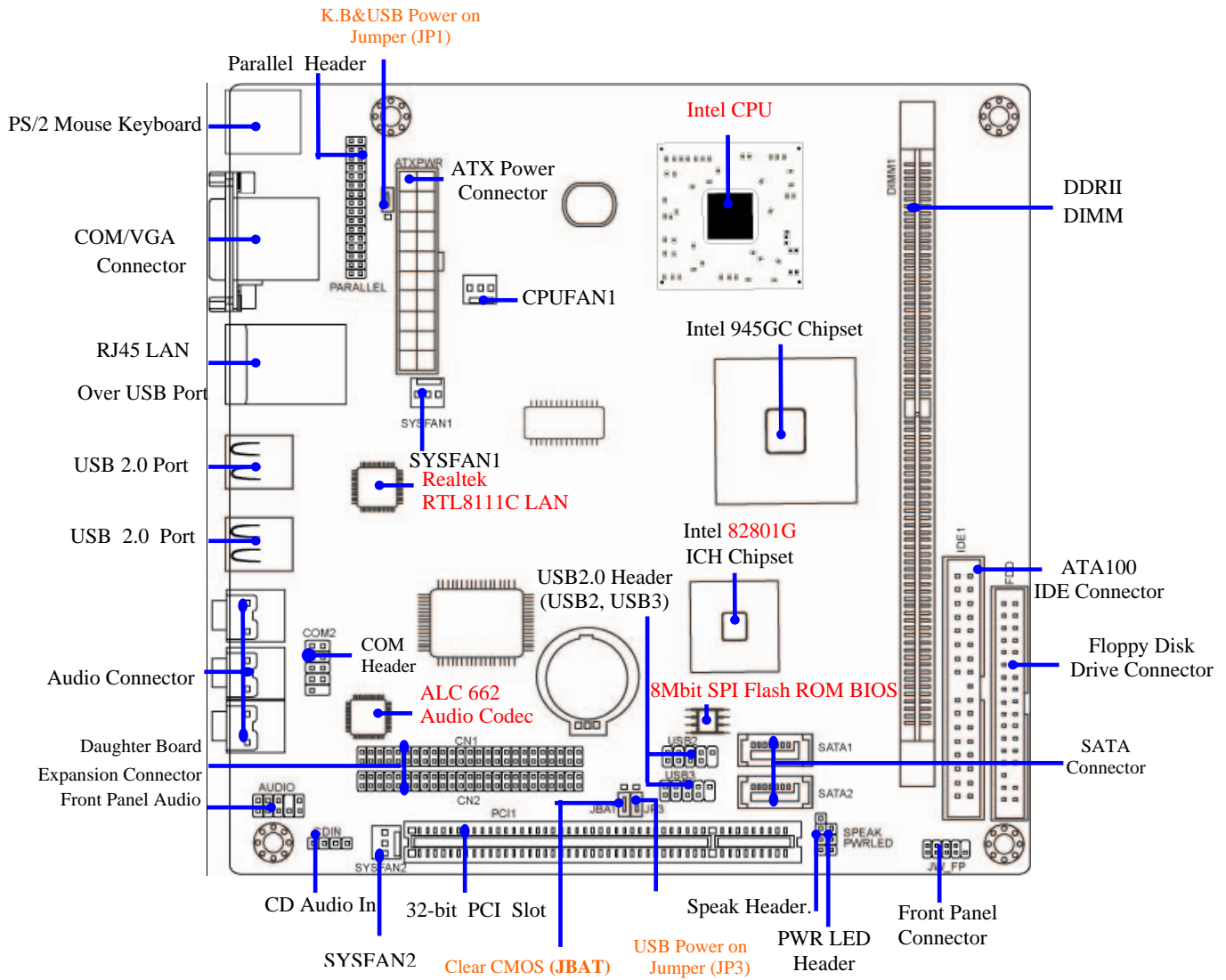

Jumper

Jumper	Name	Description	Page
JP1	KB/USB Power On Function Setting	3-pin Block	P.6
JP3	USB Power On Function Setting	3-pin Block	P.6
JBAT	CMOS RAM Clear Function Setting	3-pin Block	p.7

Connectors

Connector	Name	Description	Page
USB1,USB2	USB Port Connector	4-pin Connector	p.7
RJ-45 from UL1	RJ45 LAN Connector	8-pin Connector	p.7
VGA	VGA Port Connector	D-sub15-pin Female	p.7
COM1	Serial Port Connector	9-pin Block	p.7
Line-Out/Line-In /MIC	Line-Out/Line-In /MIC Audio Connector	3 Phone Jack	p.7
SATA1,2	Serial ATA Connectors	7-pin Connector	p.8
IDE1	IDE Connector	40-pin IDE Block	p.8
FLOPPY	Floppy Disk Connector	34-pin Block	p.9

Headers

Header	Name	Description	Page
AUDIO	Front Panel SPEAKER, MIC header	9-pin Block	p.9
CDIN	CD Audio-In Header	4-pin Block	p.9
USB2/USB3	USB2.0 Port Headers	9-pin Block	p.10
SPEAK	Speaker connector	4-pin Block	p.10
PWRLED	Power LED Headers	3-pin Block	p.10
JW_FP (PWR LED/ IDE LED/ /Power Button /Reset)	Front Panel Headers (PWR LED/ IDE LED/ /Power Button /Reset)	9-pin Block	P.11
CPUFAN, SFAN1/2	FAN Speed Headers	3-pin Block	P.12
PARALLEL	Parallel Port Header	25-pin Block	P.12
COM2	Serial Port Header	9-pin Block	P.12
CN1/CN2	Daughter Board Expansion Headers	50-pin block	p.13

Chapter 2

Jumper Setting, Connectors and Headers

2-1 Jumper Setting

(1) JP1 KB/USB Power on Function Setting

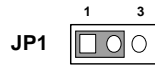
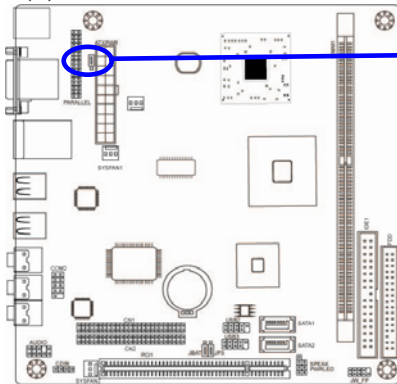

1-2 K.B.&USBPOWER-ON Disacted(default)

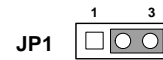

2-3 K.B& USB POWER-ON Enabled

(2) JP3 USB Power on Function Setting

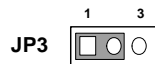
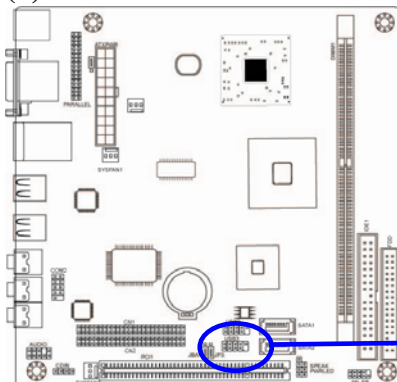

1-2 USB POWER-ON Disacted(default)

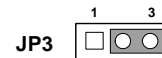

2-3 USB POWER-ON Enabled

(3) Clear CMOS (3-pin): JBAT

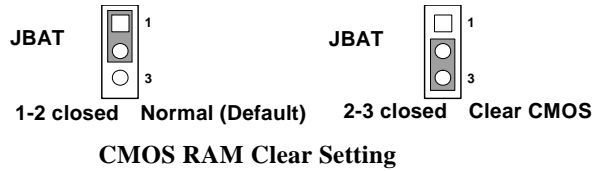
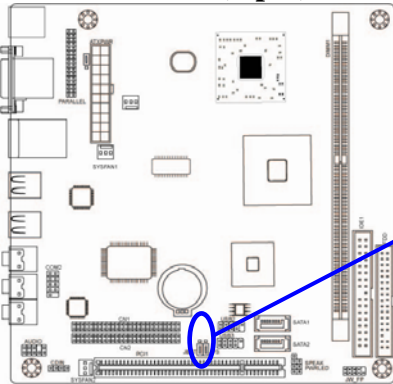

2-2 Connectors and Headers

2-2-1 Connectors

(1) I/O Back Panel Connector

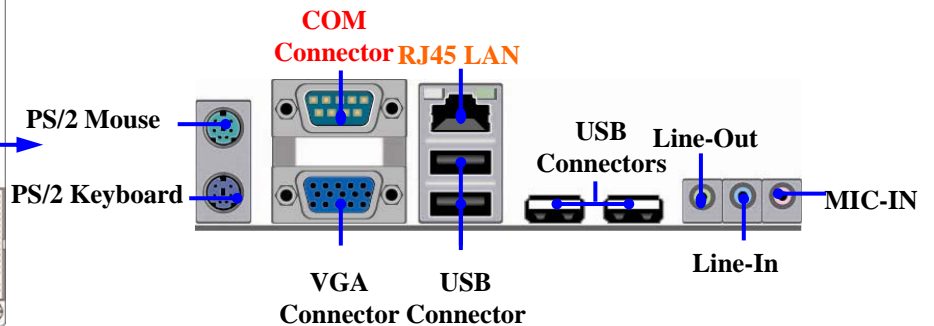
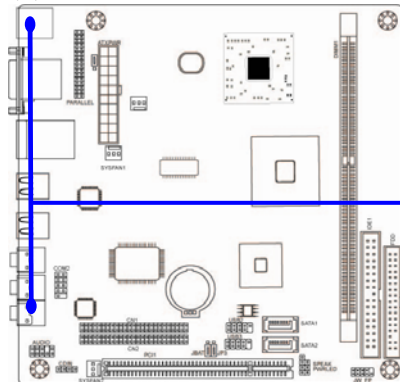

(2) Serial ATA Connector (7-pin female): SATA1/SATA2

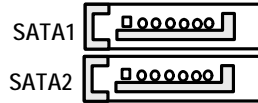
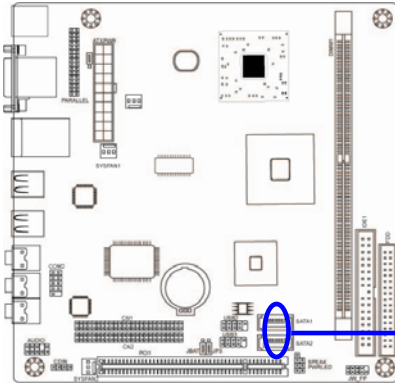

Serial-ATA2 Port Connector

(3) IDE Connector: IDE1

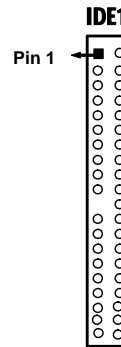
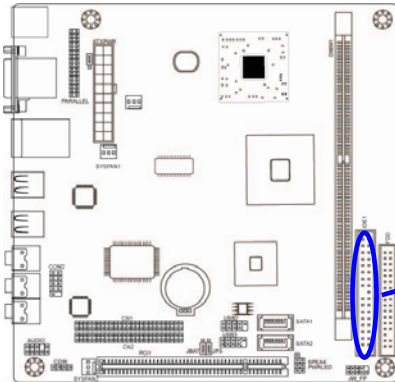

(4) Floppy drive Connector (34-pin block): FLOPPY

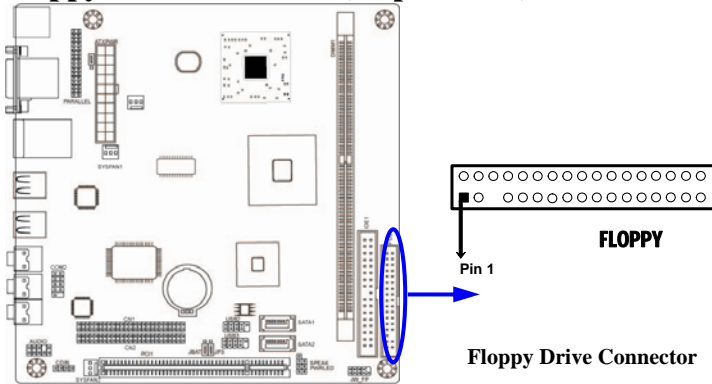

2-2-2 Headers

(1) Line-Out, MIC-In Header (14 pin): AUDIO

This header connects to Front Panel Line-out, MIC-In connector with cable.

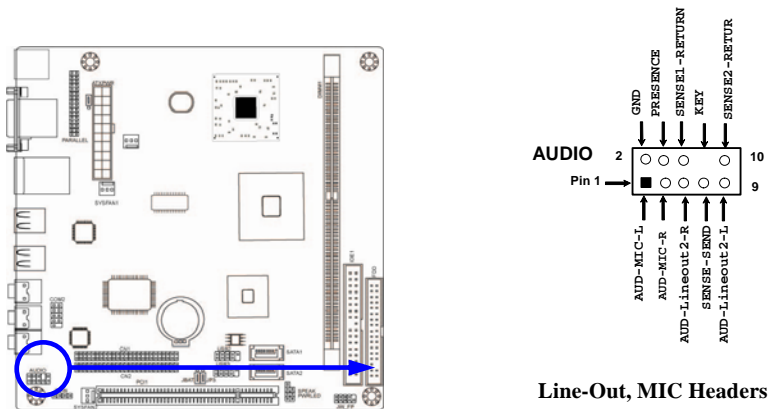

(2) CD Audio-In Headers (4-pin): CDIN

CDIN are the connectors for CD-Audio Input signal. Please connect it to CD-ROM CD-Audio output connector.

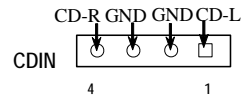
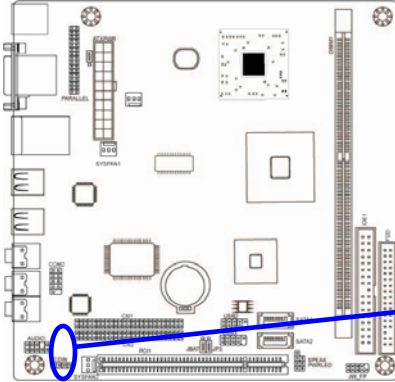

CD Audio-In Headers

(3) USB Port Headers (9-pin): USB2, USB3

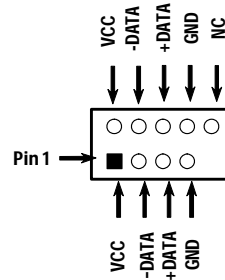
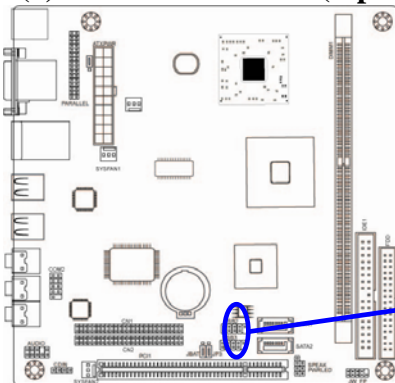

USB Port Header

(4) Speaker connector: SPEAK

This 4-pin connector connects to the case-mounted speaker. See the figure below.

(5) Power LED: PWR LED

The Power LED is light on while the system power is on. Connect the Power LED from the system case to this pin.

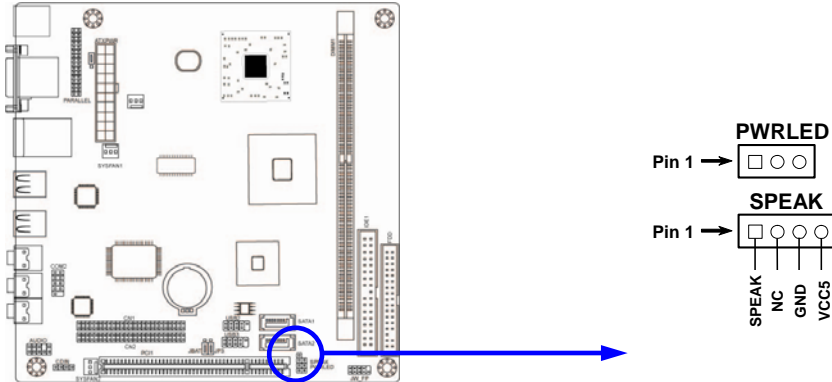

(6) Front Panel Headers: JW_FP

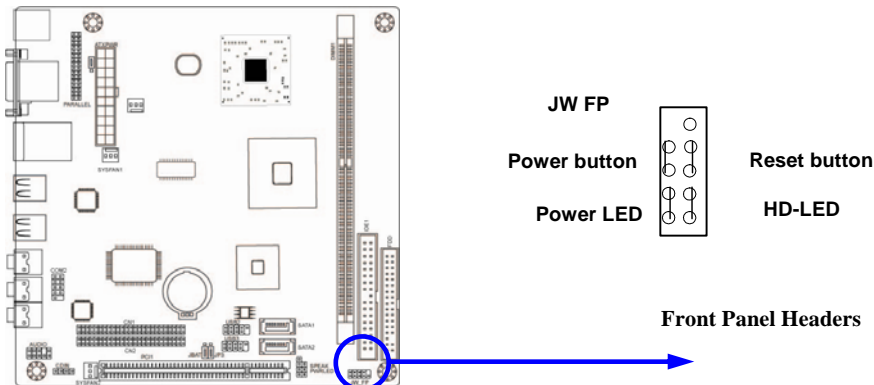

(7) FAN Speed Headers (3-pin): CPUFAN, SYSFAN1, and SYSFAN2

These connectors support cooling fans of 350mA (4.2 Watts) or less, depending on the fan manufacturer, the wire and plug may be different. The red wire should be positive, while the

black should be ground. Connect the fan's plug to the board taking into consideration the polarity of connector.

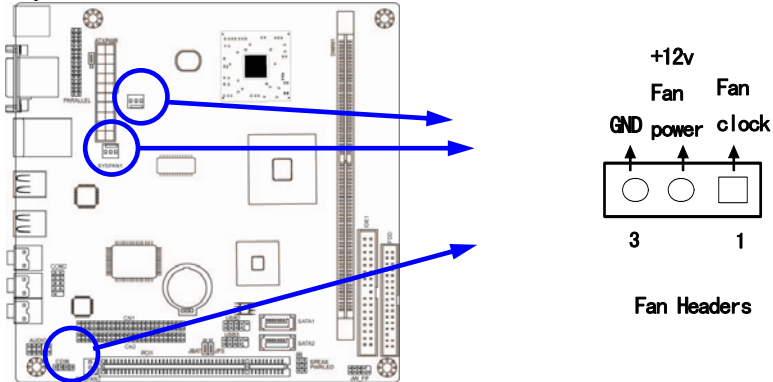

(8) Parallel Port Header: PARALLEL

The onboard parallel port header is a 25-pin connector for connecting devices such as old-fashioned printer.

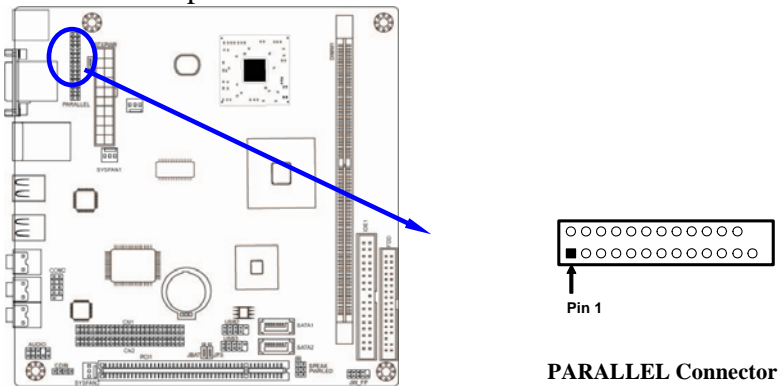

(9) Serial Port Connector (9-pin female): COM2

COM2 is a 9-pin RS232 D-Subminiature serial port connector.

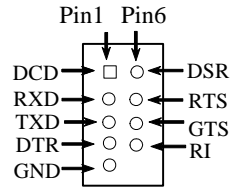
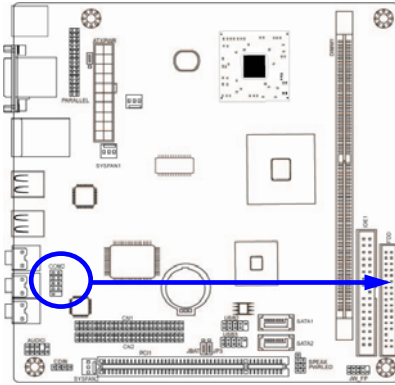

Serial COM Port 9-pin Block

(10) Expansion Daughter Board Headers: CN1/CN2

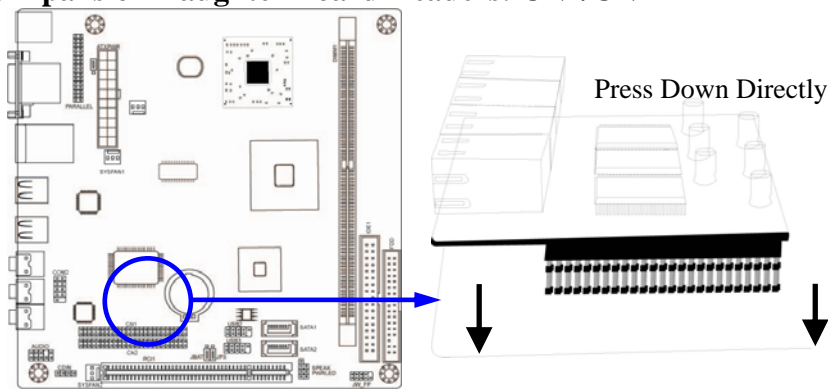

To install a daughter board into CN1, CN2 is very easy, user just press down the daughter board directly into these two connectors, in the direction shown as the above picture.

Chapter 3

Introducing BIOS

The BIOS is a program located on a Flash Memory on the motherboard. This program is a bridge between motherboard and operating system. When you start the computer, the BIOS program will gain control. The BIOS first operates an auto-diagnostic test called POST (power on self test) for all the necessary hardware, it detects the entire hardware device and configures the parameters of the hardware synchronization. Only when these tasks are completed done it gives up control of the computer to operating system (OS). Since the BIOS is the only channel for hardware and software to communicate, it is the key factor for system stability, and in ensuring that your system performance as its best.

In the BIOS Setup main menu of Figure 3-1, you can see several options. We will explain these options step by step in the following pages of this chapter, but let us first see a short description of the function keys you may use here:

- Press <Esc> to quit the BIOS Setup.
- Press ↑↓←→ (up, down, left, right) to choose, in the main menu, the option you want to confirm or to modify.
- Press <F10> when you have completed the setup of BIOS parameters to save these parameters and to exit the BIOS Setup menu.
- Press Page Up/Page Down or +/- keys when you want to modify the BIOS parameters for the active option.

3-1 Entering Setup

Power on the computer and by pressing immediately allows you to enter Setup.

If the message disappears before your respond and you still wish to enter Setup, restart the system to try again by turning it OFF then ON or pressing the “RESET” button on the system case. You may also restart by simultaneously pressing <Ctrl>, <Alt> and <Delete> keys. If you do not press the keys at the correct time and the system does not boot, an error message will be displayed and you will again be asked to

Press <F1> to continue, to enter Setup

3-2 Getting Help

Main Menu

The on-line description of the highlighted setup function is displayed at the bottom of the screen.

Status Page Setup Menu/Option Page Setup Menu

Press F1 to pop up a small help window that describes the appropriate keys to use and the possible selections for the highlighted item. To exit the Help Window, press <Esc>.

3-3 The Main Menu

Once you enter Award® BIOS CMOS Setup Utility, the Main Menu (Figure 3-1) will appear on the screen. The Main Menu allows you to select from 12 setup functions and 2 exit choices. Use arrow keys to select among the items and press <Enter> to accept or enter the sub-menu.

Phoenix - AwardBIOS CMOS Setup Utility

Standard CMOS Features	Miscellaneous Control
Advanced BIOS Features	Load optimized Defaults
Advanced Chipset Features	Load Standard Defaults
Integrated Peripherals	Set Supervisor Password
Power Management Setup	Set User Password
PnP/PCI Configuration	Save & Exit Setup
PC Health Status	Exit Without Saving
Esc : Quit	↑↓→← : Select Item
F10 : Save & Exit Setup	

Figure 3-1

Standard CMOS Features

Use this Menu for basic system configurations.

Advanced BIOS Features

Use this menu to set the Advanced Features available on your system.

Advanced Chipset Features

Use this menu to change the values in the chipset registers and optimize your system's performance.

Integrated Peripherals

Use this menu to specify your settings for integrated peripherals.

Power Management Setup

Use this menu to specify your settings for power management.

PnP/PCI Configuration

Use this menu to specify your settings for PnP/PCI Configuration.

PC Health Status

This entry shows your PC health status.

Miscellaneous Control

Use this menu to specify your settings for Miscellaneous Control.

Load Optimized Defaults

Use this menu to load the BIOS default values that are factory settings for optimal performances system operations.

Load Standard Defaults

Use this menu to load the BIOS default values for the minimal/stable performance system operation.

Set Supervisor Password

Use this menu to set supervisor password.

Set User Password

Use this menu to set user password.

Save & Exit Setup

Save CMOS value changes to CMOS and exit setup.

Exit Without Saving

Abandon all CMOS value changes and exit setup.

3-4 Standard CMOS Features

The items in Standard CMOS Setup Menu are divided into several categories. Each category includes no, one or more than one setup items. Use the arrow keys to highlight the item and then use the <PgUp> or <PgDn> keys to select the value you want in each item.

Phoenix - AwardBIOS CMOS Setup Utility
Standard CMOS Features

<pre> Date (mm:dd:yy) Wed, Aug13, 2008 Time (hh:mm:ss) 16 : 48 : 35 > SATA Port1 Master None > SATA Port1 Master None > IDE Channel 1 Master WDC WD800BB-00JHC0 > IDE Channel 1 Slave None Drive A 1.44M, 3.5 in. Video EGA/VGA Halt On All Errors Base Memory 639k Extended Memory 1039360k Total Memory 1040384k </pre>	Item Help Menu Level > Change the day, month, year and century
↑↓←→ Move Enter:Select +/-/PU/PD:Value F10:Save ESC:Exit F1:General Help F5:Previous Values F6:Optimized Defaults F7:Standard Defaults	

Date

The date format is <day><month><date><year>.

Day Day of the week is from Sun to Sat, determined by BIOS. Read-only.

Month The month is from Jan. through Dec.

Date The date from 1 to 31 can be keyed by numeric function keys.

Year The year depends on the year of the BIOS.

Time

The time format is <hour><minute><second>.

SATA Port 1/SATA Port 2 /IDE Channel 1 Master/Slave

Press Enter and then PgUp/<+> or PgDn/<-> to select Manual, None, Auto type. Note that the specifications of your drive must match with the drive table. The hard disk will not work properly if you enter improper information for this category. If the type of hard disk drives is not matched or listed, you can use Manual to define your own drive type manually.

If you select Manual, related information is asked to be entered to the following items. Enter the information directly from the keyboard. This information should be provided in the documentation from your hard disk vendor or the system manufacturer.

If the controller of HDD interface is SCSI, the selection shall be “None”.
 If the controller of HDD interface is CD-ROM, the selection shall be “None”

Access Mode The settings are CHS, LBA, Large and Auto.
Cylinder number of cylinders
Head number of heads
Precomp write precomp
Landing Zone landing zone
Sector number of sectors

3-5 **Advanced BIOS Features**

Phoenix - AwardBIOS CMOS Setup Utility

Advanced BIOS Features

Virus Warning	Disabled	Item Help
CPU L3 Cache	Enabled	
CPU Feature	Press Enter	Menu Level >
Hard Disk Boot Priority	Press Enter	
Hyper-Threading Technology	Enabled	
Quick Power On Self Test	Enabled	
First Boot Device	Floppy	
Second Boot Device	Hard Disk	
Third Boot Device	CDROM	
Boot Other Device	Enabled	
Boot Up Floppy Seek	Disabled	
Boot Up NumLock Status	On	
Typematic Rate Setting	Disabled	
Typematic Rate (Chars/Sec)	6	
Typematic Delay (Msec)	250	
Security Option	Setup	
APIC Mode	Enabled	
MPS Version Control For OS	1.4	
OS Select For DRAM > 64MB	Non-OS2	
↑↓→← Move Enter:Select +/-/PU/PD:Value F10:Save ESC:Exit F1:General Help F5:Previous Values F6:Optimized Defaults F7:Standard Defaults		

Hard Disk Boot Priority

The selection is for you to choose the hard disk drives priorities to boot from.

Virus Warning

The selection allows you to choose the VIRUS Warning feature for IDE Hard Disk booting sector protection. If this function is enabled and someone attempt to write data into this area, BIOS will show a warning message on screen and alarm beep.

Disabled (default) No warning message to appear when anything attempts to access the boot sector or hard disk partition table.

Enabled Activates automatically when the system boots up causing a warning message to appear when anything attempts to access the boot sector of hard disk partition table.

Quick Power On Self-Test

This category speeds up Power On Self Test (POST) after you power on the computer. If this is set to Enabled, BIOS will shorten or skip some check items during POST.

Enabled (default) Enable quick POST

Disabled Normal POST

First/Second/Third Boot Device/Boot Other Device

The BIOS attempts to load the operating system from the devices in the sequence selected in these items. The settings are Floppy, LS120, Hard disk, CDROM, ZIP100,USB-FDD, USB-ZIP, USB-COROM, Legacy LAN and Disabled.

Boot Up Floppy Seek

During POST, BIOS will determine if the floppy disk drive installed is 40 or 80 tracks. 360K type is 40 tracks while 760K, 1.2M and 1.44M are all 80 tracks.

Boot Up NumLock Status

The default value is On.

On (default) Keypad is numeric keys.

Off Keypad is arrow keys.

Typematic Rate Setting

Keystrokes repeat at a rate determined by the keyboard controller. When enabled, the typematic rate and typematic delay can be selected. The settings are: Enabled/Disabled.

Typematic Rate (Chars/Sec)

Set the number of times a second to repeat a keystroke when you hold the key down. The settings are: 6, 8, 10, 12, 15, 20, 24, and 30.

Typematic Delay (Msec)

Sets the delay time after the key is held down before it begins to repeat the keystroke. The settings are 250, 500, 750, and 1000.

Security Option

This category allows you to limit access to the system and Setup, or just to Setup.

System The system will not boot and access to Setup will be denied if the correct password is not entered at the prompt.

Setup (default) The system will boot, but access to Setup will be denied if the correct password is not entered prompt.

MPS Version Control For OS 1.4

This option is only valid for multiprocessor motherboards as it specifies the version of the Multiprocessor Specification (MPS) that the motherboard will use. The optional settings are: 1.1 and 1.4.

OS Select For DRAM > 64MB

Allows OS2[®] to be used with >64MB or DRAM. Settings are Non-OS/2 (default) and OS2. Set to OS/2 if using more than 64MB and running OS/2[®].

3-6 Advanced Chipset Features

The Advanced Chipset Features Setup option is used to change the values of the chipset registers. These registers control most of the system options in the computer.

Phoenix - AwardBIOS CMOS Setup Utility
Advanced Chipset Features

DRAM Timing Selectable	By SPD	Item Help
* SDRAM CAS Latency Time	Auto	Menu Level >
* SDRAM Cycle Time	Auto	
* SDRAM RAS# to CAS# Delay	Auto	
* SDRAM RAS# Precharge Time	Auto	
System BIOS Cacheable	Disabled	
Video BIOS Cacheable	Disabled	
Memory Hole at 15-16M	Disabled	
** VGA Setting**		
Onchip Frame Buffer Size	8MB	
DVMT Mold	DVMT	
DVMT/FIXED Memory Size	128MB	
↑↓←→ Move Enter:Select +/-/PU/PD:Value F10:Save ESC:Exit F1:General Help F5:Previous Values F6:Optimized Defaults F7:Standard Defaults		

SDRAM CAS Latency Time

When synchronous DRAM is installed, the number of clock cycles of CAS latency depends on the DRAM timing. The settings are: Auto, 3, 4 and 5.

SDRAM RAS-to-CAS Delay

This field let's you insert a timing delay between the CAS and RAS strobe signals, used when DRAM is written to, read from, or refreshed. *Fast* gives faster performance; and *Slow* gives more stable performance. This field applies only when synchronous DRAM is installed in the system.

SDRAM Ras Precharge Time

If an insufficient number of cycles is allowed for the RAS to accumulate its charge before DRAM refresh, the refresh may be incomplete and the DRAM may fail to retain date. *Fast* gives faster performance; and *Slow* gives more stable performance. This field applies only when synchronous DRAM is installed in the system.

System BIOS Cacheable

Selecting Enabled allows caching of the system BIOS ROM at F0000h-FFFFFh, resulting in better system performance. However, if any program writes to this memory area, a system error may result. The settings are: Enabled and Disabled.

Onchip Frame Buffer Size

Use this item to set onchip frame buffer size. The optional settings are: 1MB and 8MB.

DVMT Mold

The optional settings are: FIXED, DVMT and BOTH.

DVMT/FIXED Memory Size

The optional settings are: 64MB, 128MB and 224 MB.

3-7 Integrated Peripherals

Phoenix - AwardBIOS CMOS Setup Utility

Integrated Peripherals

> Onboard IDE Function	Press Enter	Item Help
> Onboard Device Function	Press Enter	
> Onboard Super IO Function	Press Enter	Menu Level >
PWR status after PWR Failure	Always Off	
Init Display First	PCI Slot	
↑↓→← Move Enter:Select +/-/PU/PD:Value F10:Save ESC:Exit F1:General Help F5:Previous Values F6:Optimized Defaults F7:Standard Defaults		

Onboard IDE Function

Please refer to section 3-7-1

Onboard Device Function

Please refer to section 3-7-2

Onboard Super IO Function

Please refer to section 3-7-3

PWR Status after PWR Failure

The settings are: Former Status; Always On; Always Off.

Init Display First

This item allows you to decide to whether activate PCI Slot or Onchip VGA first. The settings are: **PCI Slot, Onchip VGA.**

3-7-1 Onboard IDE Function

Phoenix - AwardBIOS CMOS Setup Utility

Onboard IDE Function

OnChip IDE Channel	Enabled	Item Help	
IDE Channel Master PIO	Auto		
IDE Channel Slave PIO	Auto	Menu Level >>	
IDE Channel Master UDMA	Auto		
IDE Channel Slave UDMA	Auto		
IDE DMA Transfer Access	Enabled		
IDE HDD Block Mode	Enabled		
*SATA Port Speed Settings	Disabled		
↑↓→← Move Enter:Select +/-/PU/PD:Value F10:Save ESC:Exit F1:General Help F5:Previous Values F6:Optimized Defaults F7:Standard Defaults			

IDE DMA transfer access

The integrated peripheral controller contains an IDE interface with support for one IDE channels. Select *Enabled* to activate each channel separately. The settings are: Enabled and Disabled.

IDE Channel Master/Slave PIO

The two IDE PIO (Programmed Input/Output) fields let you set a PIO mode (0-2) for each of the two IDE devices that the onboard IDE interface supports. Modes 0 through 2 provide successively increased performance. In Auto mode, the system automatically determines the best mode for each device. The settings are: Auto, Mode 0, Mode 1, Mode 2, Mode 3, Mode 4.

IDE Channel Master/Slave UDMA

Ultra DMA/33 implementation is possible only if your IDE hard drive supports it and the operating environment includes a DMA driver (Windows 95 OSR2 or a third-party IDE bus master driver). If your hard drive and your system software both support Ultra DMA/33 and Ultra DMA/66, select Auto to enable BIOS support. The settings are: Auto, Disabled.

IDE HDD Block Mode

Block mode is also called block transfer, multiple commands, or multiple sector read/write. If your IDE hard drive supports block mode (most new drives do), select Enabled for automatic detection of the optimal number of block read/writes per sector the drive can support. The settings are: Enabled, Disabled.

SATA Port Speed Settings

The optional settings are: Disabled, Force GEN1 and Force GEN2.

3-7-2 Onboard Device Function

Phoenix - AwardBIOS CMOS Setup Utility

Onboard Device Function

Onboard PCIE LAN Controller	Enabled	Item Help
Onboard PCIE LAN BootROM	Disabled	
High Definition Audio	Enabled	Menu Level >>
USB Host Controller	Enabled	
USB 2.0 Function	Enabled	
USB Keyboard Legacy Support	Disabled	
USB Mouse Legacy Support	Disabled	
USB Storage Legacy Support	Disabled	
USB Mass Storage Device Boot Setting		
↑↓→← Move Enter:Select +/-/PU/PD:Value F10:Save ESC:Exit F1:General Help F5:Previous Values F6:Optimized Defaults F7:Standard Defaults		

Onboard PCIE LAN Controller

Setting to [Enabled] allows the BIOS to auto-detect the LAN controller and enable it. Setting options:[Enabled] and [Disabled] .

High Definition Audio

The selection for you to choose the embedded Audio function or 3rd party audio interface installed. The settings are: Enabled and Disabled.

USB 2.0 Function Keyboard/Mouse /Storage Latency Support

Select *Enabled* if your system contains a Universal Serial Bus (USB) controller and you have a USB Mouse /keyboard. The settings are: Enabled, Disabled.

3-7-3 Onboard Super IO Function

Phoenix - AwardBIOS CMOS Setup Utility

Onboard Super IO Function

Onboard FDD Controller	Enabled	Item Help
Onboard Serial Port1	3F8/IRQ4	
Onboard Serial Port2	2F8/IRQ3	Menu Level >>
UART2 Mode Select	Normal	
* IR Duplex Mode	Half	
Onboard Parallel Port	378/IRQ7	
Parallel Port Mode	SPP	
*ECP Mold Use DMA	3	
↑↓→← Move Enter:Select +/-/PU/PD:Value F10:Save ESC:Exit F1:General Help F5:Previous Values F6:Optimized Defaults F7:Standard Defaults		

Onboard FDD Controller

Select Enabled if your system has a floppy disk controller (FDD) installed on the system board and you wish to use it. If you install add-on FDC or the system has no floppy drive, select Disabled in this field. The settings are: Enabled and Disabled.

Onboard Serial Port 1

The optional settings are : Disabled, 3F8/IRQ4 , 2F8/IRQ3, 3E8/IRQ4 , 2E8/IRQ3, 4E0/IRQ4, 4E8/IRQ3 and Auto.

Onboard Serial Port 2

The optional settings are : Disabled, 3F8/IRQ4 , 2F8/IRQ3, 3E8/IRQ4 , 2E8/IRQ3, 4E0/IRQ4, 4E8/IRQ3 and Auto.

UART2 Mode Select

This item allows you to determine which InfraRed(IR) function of the onboard I/O chip. The optional settings are Normal and IrDA.

IrDA Duplex Mode

This field is available when UART Mode is set to either ASKIR or IrDA. This item enables you to determine the infrared function of the onboard infrared chip. The options are Full and Half

(default). Full-duplex means that you can transmit and send information simultaneously. Half-duplex is the transmission of data in both directions , but only one direction at a time.

Onboard Parallel Port

The optional settings are: Disabled, 378/IRQ7, 278/IRQ5 AND 3BC/IRQ7.

Parallel Port Mode

SPP : Standard Parallel Port

EPP : Enhanced Parallel Port

ECP : Enhanced Com Port

SPP/EPP/ECP/ECP+EPP

To operate the onboard parallel port as Standard Parallel Port only, choose “SPP.” To operate the onboard parallel port in the EPP modes simultaneously, choose “EPP.” By choosing “ECP”, the onboard parallel port will operate in ECP mode only. Choosing “ECP+EPP” will allow the onboard parallel port to support both the ECP and EPP modes simultaneously. The ECP mode has to use the DMA channel, so choose the onboard parallel port with the ECP feature. After selecting it, the following message will appear: “ECP Mode Use DMA” at this time, the user can choose between DMA channels 3 to 1. The onboard parallel port is EPP Spec. compliant, so after the user chooses the onboard parallel port with the EPP function, the following message will be displayed on the screen: “EPP Mode Select.” At this time either EPP 1.7 spec. or EPP 1.9 spec. can be chosen.

3-8 Power Management Setup

The Power Management Setup allows you to configure your system to most effectively save energy saving while operating in a manner consistent with your own style of computer use.

Phoenix - AwardBIOS CMOS Setup Utility

Power Management Setup

ACPI Function	Enabled	Item Help
ACPI Suspend Type	S1(DOS)	
Power Management	User Define	Menu Level >
Video off Method	V/H SYNC+Blank	
Video Off In Suspend	Yes	
Suspend Type	Stop Grant	
MODEM Use IRQ	3	
Suspend Mode	Disabled	
HDD Power Down	Disabled	
Soft-off by PWR-BTTN	Instant-off	
Wake-Up by PCI card	Disabled	
Power On by Ring	Disabled	
Wake-up by USB KB from S3(S4)	Disabled	
PS2 KB/MS Wake-up from S4-S5	Disabled	
Resume by Alarm	Disabled	
X Date (of Month)Alarm	0	
X Time (hh:mm:ss)Alarm	0 : 0 :0	
PM Timer Reload Event	Press Enter	
PCI Express PM Reload Function	Press Enter	
↑↓→← Move Enter:Select +/-/PU/PD:Value F10:Save ESC:Exit F1:General Help F5:Previous Values F6:Optimized Defaults F7:Standard Defaults		

ACPI Function

This item allows you to Enabled/Disabled the Advanced Configuration and Power Management (ACPI). The settings are Enabled and Disabled.

Video Off Method

This determines the manner in which the monitor is blanked.

- DPMS (default)** Initial display power management signaling.
- Blank Screen** This option only writes blanks to the video buffer.
- V/H SYNC+Blank** This selection will cause the system to turn off the vertical and horizontal synchronization ports and write blanks to the video buffer.

Suspend Type

The settings are: Stop and PWR On Suspend.

MODEM Use IRQ

If you want an incoming call on a modem to automatically resume the system from a power-saving mode, use this item to specify the interrupt request line (IRQ) that is used by the modem. You might have to connect the fax/modem to the motherboard Wake On Modem connector for this feature to work.

Soft-Off by PWRBTN

Under ACPI (Advanced Configuration and Power management Interface) you can create a software power down. In a software power down, the system can be resumed by Wake up Alarms. This item lets you install a software power down that is controlled by the power Button on your system. If the item is set to Instant-Off, then the power button causes a software power down. If the item is set to Delay 4 Sec, then you have to hold the power button down for four seconds to cause a software power down. The settings are: Delay 4 Sec, Instant-Off.

Power On by Ring

During Disabled, the system will ignore any incoming call from the modem. During Enabled, the system will boot up if there's an incoming call from the modem.

Resume by Alarm

This function is for setting date and time for your computer to boot up. During Disabled, you cannot use this function. During Enabled, choose the Date and Time Alarm:

Date(of month) Alarm

You can choose which month the system will boot up. Set to 0, to boot every day.

Time(hh:mm:ss) Alarm

You can choose what hour, minute and second the system will boot up.

Note: If you have change the setting, you must let the system boot up until it goes to the operating system, before this function will work.

PM Timer Reload Event

In this item users can either select Enabled or Disabled to enable or disable Primary IDE 0; Primary IDE 1;Secondary IDE 0; Secondary IDE 1; FDD, COM, LPT Port or PCI PIRQ(A-D).

PCI Express PME Function

Press Enter to either set Enabled or Disabled the PCI Express PM Function.

3-9 PnP/PCI Configuration

Phoenix - AwardBIOS CMOS Setup Utility

PnP/PCI Configuration

IRQ Resources	Press Enter	Item Help
PCI/ VGA Palette Snoop	Disabled	
*****PCI Express Relative Items*****		
Maximum Payload Size	128	Menu Level >
↑↓→← Move Enter:Select +/-/PU/PD:Value F10:Save ESC:Exit F1:General Help F5:Previous Values F6:Optimized Defaults F7:Standard Defaults		

PCI/VGA Palette Snoop

This item is designed to overcome problems that can be caused by some non-standard VGA cards. This board includes a built-in VGA system that does not require palette snooping so you must leave this item disabled.

IRQ Resources

Names the interrupt request (IRQ) line assigned to the USB on your system. Activity of the selected IRQ always awakens the system.

3-10 PC Health Status

This section shows the Status of you CPU, Fan, and Warning for overall system status. This is only available if there is Hardware Monitor onboard.

Phoenix - AwardBIOS CMOS Setup Utility

PC Health Status

Shutdown Temperature	Disabled	Item Help
CPU Thermal-Throttling	Disabled	
* CPU Thermal-Throttling Temp	70°C	Menu Level >
* CPU Thermal-Throttling Duty	50.00%	
* CPU Thermal-Throttling Beep	Enabled	
Show PC Health in POST	Enabled	
> Smart FAN Configurations	Press Enter	
VCC3v	3.31V	
Vcore	1.28V	
NB	1.26V	
+5V	5.12V	
+12V	11.88V	
5VSB	5.00V	
VDIMM	1.87V	
VSB3V	3.37V	
Vbat	3.28V	
CPU Temperature	64°C/147°F	
System Temperature	38°C/96°F	
CPUFAN Speed	2912RPM	
SYSFAN1 Speed	5836 RPM	
SYSFAN2 Speed	0 RPM	
↑↓→← Move Enter:Select +/-/PU/PD:Value F10:Save ESC:Exit F1:General Help F5:Previous Values F6:Optimized Defaults F7:Standard Defaults		

Shutdown Temperature

This item can let users setting the Shutdown temperature, when CPU temperature over this setting the system will auto shutdown to protect CPU.

Show PC Health in Post

During Enabled, it displays information list below. The choice is either Enabled or Disabled

CPU Temperature/ System Temperature/CPU FAN Speed, SYS FAN1, SYSFAN2 Speed/VCC 3V/Vcore/ NB/+5V/+12V/5VSB(V)/VDIMM/VSB3V/Vbat

This will show the CPU/FAN/System voltage chart and FAN Speed.

3-11 Miscellaneous Control

Phoenix - AwardBIOS CMOS Setup Utility

Miscellaneous Control

Auto Detect PCI Clock	Disabled	Item Help
Spread Spectrum	Disabled	
** Current Host/PCI Clock is 133/33MHZ**		
Host/PCI Clock at Next Boot is	133/33MHZ	Menu Level >
** Current DRAM CLOCK 533 MHz **		
DRAM Clock at Next Boot	By SPD(DDR533MHz)	
VDIMM Select	1.85V(Default)	
VCC NB Select	1.53v(Default)	
GMCH VCCP Select	1.12v(Default)	
VDA C25 Select	2.50v(Default)	
↑↓→← Move Enter:Select Item +/-/PU/PD:Value F10:Save ESC:Exit F1:General Help F5:Previous Values F6:Optimized Defaults F7:Standard Defaults		

Auto Detect PCI Clock

This item allows you to enable/disable auto detect PCI Clock.

The settings are: Enabled, Disabled.

Spread Spectrum

This item allows you to set the Spread Spectrum as Enable or Disabled.

Host/PCI Clock at Next Boot

This item allows you to select the CPU/PCI Clock.

DRAM Clock at Next Boot

This item allows you to set DRAM clock.

VDIMM Select

This item allows you to set the voltage of DRAM DIMM. The optional settings are: 1.85v (Default), 1.95v, 2.05v and 2.15v.

VCC NB Select

This item allows you to set Northbridge voltage. The optional settings are from 1.41v to 1.99v.

GMCH VCCP Select

The optional settings are from 1.04v to 1.46v.

VDAC25 Select

The optional settings are from 2.31v to 3.25v.

3-12 Password Setting

You can set either supervisor or user password, or both of them. The differences are:

Supervisor password: Can enter and change the options of the setup menus.

User password: Can only enter but do not have the right to change the options of the setup menus. When you select this function, the following message will appear at the center of the screen to assist you in creating a password.

ENTER PASSWORD:

Type the password, up to eight characters in length, and press <Enter>. The password typed now will clear any previously entered password from CMOS memory. You will be asked to confirm the password. Type the password again and press <Enter>. You may also press <Esc> to abort the selection and not enter a password.

To disable a password, just press <Enter> when you are prompted to enter the password. A message will confirm that the password will be disabled. Once the password is disabled, the system will boot and you can enter Setup freely.

PASSWORD DISABLED.

When a password has been enabled, you will be prompted to enter it every time you try to enter Setup. This prevents an unauthorized person from changing any part of your system configuration.

Additionally, when a password is enabled, you can also require the BIOS to request a password every time your system is rebooted. This would prevent unauthorized use of your computer.

You determine when the password is required within the BIOS Features Setup Menu and its Security option. If the Security option is set to “System”, the password will be required both at boot and at entry to Setup. If set to “Setup”, prompting only occurs when trying to enter Setup.

3-13 Load Standard/Optimized Defaults

Load Standard Defaults

When you press <Enter> on this item, you get confirmation dialog box with a message similar to:

Load Standard Defaults (Y/N)? N

Pressing <Y> loads the BIOS default values for the most stable, minimal-performance system operations.

Load Optimized Defaults

When you press <Enter> on this item, you get a confirmation dialog box with a message similar to:

Load Optimized Defaults (Y/N)? N

Pressing <Y> loads the default values that are factory settings for optimal performance system operations.