

TECHNICAL MANUAL
Of
Intel Pine Trail-D & NM10 Chipset
Based
Mini-ITX M/B for ATOM Processor

NO.G03-NC98-F

Revision: 4.0

Release date: December, 2010

Trademark:

* Specifications and Information contained in this documentation are furnished for information use only, and are subject to change at any time without notice, and should not be construed as a commitment by manufacturer.

Environmental Protection Announcement

Do not dispose this electronic device into the trash while discarding. To minimize pollution and ensure environment protection of mother earth, please recycle.



TABLE OF CONTENT

ENVIRONMENTAL SAFETY INSTRUCTION.....	iii
USER'S NOTICE	iv
MANUAL REVISION INFORMATION.....	iv
ITEM CHECKLIST	iv
CHAPTER 1 INTRODUCTION OF THE MOTHERBOARD	
1-1 FEATURE OF MOTHERBOARD.....	1
1-2 SPECIFICATION	2
1-3 LAYOUT DIAGRAM.....	3
CHAPTER 2 HARDWARE INSTALLATION	
2-1 JUMPER SETTING	5
2-2 CONNECTORS AND HEADERS.....	7
2-2-1 CONNECTORS	7
2-2-2 HEADERS	9
CHAPTER 3 INTRODUCING BIOS	
3-1 ENTERNING SETUP.....	14
3-2 GETTING HELP	14
3-3 THE MAIN MENU.....	14
3-4 STANDARD BIOS FEATURES	16
3-5 ADVANCED BIOS FEATURES	18
3-5-1 CPU FEATURE	20
3-6 INTEGRATED PHERIPHRLALS	21
3-6-1 ONBOARD SATA FUNCTION	22
3-6-2 ONBOARD DEVICE FUNCTION.....	22
3-6-3 ONBOARD SUPER IO FUNCTION	23
3-7 POWER MANAGEMENT SETUP.....	24
3-8 PNP/PCI CONFIGURATIONS.....	25
3-9 PC HEALTH STATUS.....	26
3-9-1 SMART FAN CONFIGURATIONS.....	27
3-10 MISCELLANEOUS CONTROL.....	28
3-11 PASSWORD SETTING	29
3-12 LOAD OPTIMIZED /STANDARDDEFAULTS	30
3-13 SAVE AND EXIT SETUP/EXIT WITHOUT SAVING	30



Environmental Safety Instruction

- Avoid the dusty, humidity and temperature extremes. Do not place the product in any area where it may become wet.
- 0 to 60 centigrade is the suitable temperature. (The figure comes from the request of the main chipset)
- Generally speaking, dramatic changes in temperature may lead to contact malfunction and crackles due to constant thermal expansion and contraction from the welding spots' that connect components and PCB. Computer should go through an adaptive phase before it boots when it is moved from a cold environment to a warmer one to avoid condensation phenomenon. These water drops attached on PCB or the surface of the components can bring about phenomena as minor as computer instability resulted from corrosion and oxidation from components and PCB or as major as short circuit that can burn the components. Suggest starting the computer until the temperature goes up.
- The increasing temperature of the capacitor may decrease the life of computer. Using the close case may decrease the life of other device because the higher temperature in the inner of the case.
- Attention to the heat sink when you over-clocking. The higher temperature may decrease the life of the device and burned the capacitor.

USER'S NOTICE

COPYRIGHT OF THIS MANUAL BELONGS TO THE MANUFACTURER. NO PART OF THIS MANUAL, INCLUDING THE PRODUCTS AND SOFTWARE DESCRIBED IN IT MAY BE REPRODUCED, TRANSMITTED OR TRANSLATED INTO ANY LANGUAGE IN ANY FORM OR BY ANY MEANS WITHOUT WRITTEN PERMISSION OF THE MANUFACTURER.

THIS MANUAL CONTAINS ALL INFORMATION REQUIRED TO USE THIS MOTHER-BOARD SERIES AND WE DO ASSURE THIS MANUAL MEETS USER'S REQUIREMENT BUT WILL CHANGE, CORRECT ANY TIME WITHOUT NOTICE. MANUFACTURER PROVIDES THIS MANUAL "AS IS" WITHOUT WARRANTY OF ANY KIND, AND WILL NOT BE LIABLE FOR ANY INDIRECT, SPECIAL, INCIDENTAL OR CONSEQUENTIAL DAMAGES (INCLUDING DAMAGES FOR LOSS OF PROFIT, LOSS OF BUSINESS, LOSS OF USE OF DATA, INTERRUPTION OF BUSINESS AND THE LIKE).

PRODUCTS AND CORPORATE NAMES APPEARING IN THIS MANUAL MAY OR MAY NOT BE REGISTERED TRADEMARKS OR COPYRIGHTS OF THEIR RESPECTIVE COMPANIES, AND THEY ARE USED ONLY FOR IDENTIFICATION OR EXPLANATION AND TO THE OWNER'S BENEFIT, WITHOUT INTENT TO INFRINGE.

Manual Revision Information

Reversion	Revision History	Date
4.0	Fourth Edition	December, 2010

Item Checklist

- Motherboard
- DVD for motherboard utilities
- Motherboard User's Manual
- Cable(s)
- I/O Back panel shield

Chapter 1

Introduction of the Motherboard

1-1 Feature of motherboard

- Intel Pine Trail-D + NM10 chipset + NV GT218 GPU.
- Onboard Intel Atom CPU, with low power consumption never denies high performance.
- Support Front Side Bus 667 MHz.
- Support DDRII DIMM 667/800 up to 4GB.
- Onboard Realtek RTL 8111DL Gigabit Ethernet LAN.
- Integrated ALC662 6-channel HD Audio Codec.
- Support USB2.0 data transport demands.
- Support MINI-PCIE x1 slot
- Compliance with EuP Standard.

1-2 Specification

Spec	Description
Design	<ul style="list-style-type: none"> ● Mini-ITX form factor 6 layers ; PCB size: 17.0x17.0cm
Chipset	<ul style="list-style-type: none"> ● Intel Pine Trail-D + NM10 Chipset +NV GT218 GPU
Embedded CPU	<ul style="list-style-type: none"> ● ATOM CPU
Memory Socket	<ul style="list-style-type: none"> ● 240-pin DDRII DIMM slot x2 ● Support DDRII 667/800 MHz DDRII memory modules ● Expandable to 4GB
Expansion Slots	<ul style="list-style-type: none"> ● MINI-PCIE slot x1
LAN	Integrated Realtek RTL 8111DL Gigabit Ethernet LAN that supports Fast Ethernet LAN function of providing 10Mb/100Mb/1000Mb Ethernet data transfer rate
Audio	<ul style="list-style-type: none"> ● ALC662 6-channel Audio Codec integrated ● Audio driver and utility included
BIOS	<ul style="list-style-type: none"> ● AMI 8MB DIP Flash ROM
Multi I/O	<ul style="list-style-type: none"> ● PS/2 keyboard connector x1 ● PS/2 mouse connector x1 ● VGA port connector x1 ● HDMI connector x 1 ● DVI connector x1 (HDMI Connector and DVI Connector can not be used at the same time) ● USB port connector x4 and USB header x2 ● RJ-45 LAN connector x1 ● Audio connector x1 ● SATAII Connector x4 ● Front panel audio header x1 ● Serial port header x1 ● CIR header x1 ● GPIO header x1 ● CDIN header x1

1-3 Layout Diagram

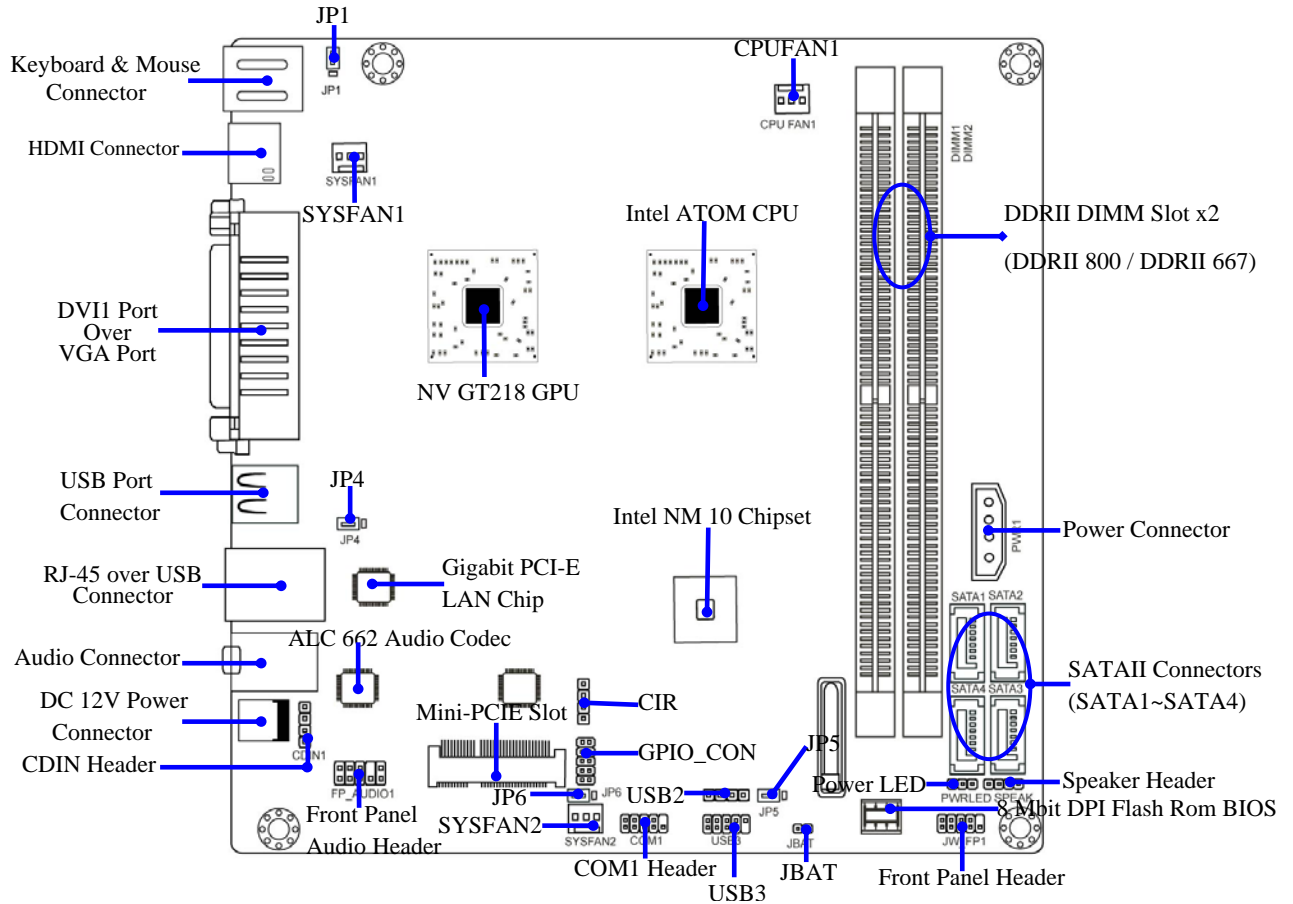
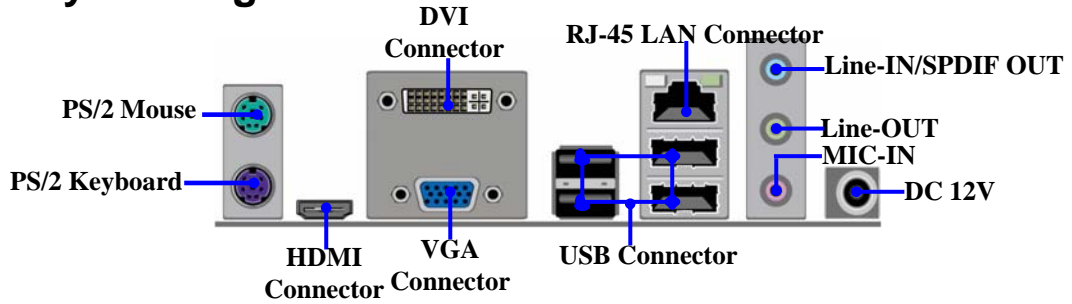

Jumper

Jumper	Name	Description
JBAT	CMOS RAM Clear Function Setting	2-pin Block
JP1	K/B / USB1 Power On Function Setting	3-pin Block
JP4	USB Power On Function Setting	3-pin Block
JP5	USB 2/3 Power On Function Setting	3-pin Block
JP6	MINI PCIE Slot Power3.3V/3.3VSB Function Select	3-pin Block

Connectors

Connector	Name	Description
DC12V_IN1	DC power Connector	DC Jack
PWR1	Power out Connector	4-pin Connector
KB1	PS2 Keyboard & Mouse Connector	6-pin Female
HDMI	High-Definition Multimedia Interface	19-pin Connector
VGA1	Video Graphic Attach Connector	15-pin Female
DVI1	Digital Visual Interface	29-pin Connector
USB1	USB Port Connectors	4-pin Connectors
USB from UL1	USB Port Connectors	4-pin Connectors
LAN from UL1	RJ-45 LAN Connectors	8-pin Connectors
AUDIO1	Line Out , MIC ,Line In/SPDIF OUT Audio Connector	3 Phone JACK
SATA1/SATA2 SATA3/SATA4	Serial ATAII Connectors	7-pin Connector

Headers

Header	Name	Description
FP_AUDIO1	Front panel audio Headers	9-pin block
CDIN1	CD Audio-In Header	4-pin Block
COM1	Serial Port Header	9-pin Block
USB2	USB Header	4-pin Block
USB3	USB Header	9- pin Block

JW_FP (PWR LED/ HD LED/ /Power Button /Reset)	Front Panel Header (PWR LED/ HD LED/ Button /Reset)	9-pin Block
PWR LED	Power LED	3-pin Block
SPEAK	Speaker Header	4-pin Block
CPUFAN1,SYSFAN1/2	FAN Speed Headers	3-pin Block
GPIO_CON	GPIO Header	10-pin Block
CIR	CIR Header	4-pin Block

Chapter 2 Hardware Installation

2-1 Jumper Setting

(1) Clear CMOS (2-pin): JBAT

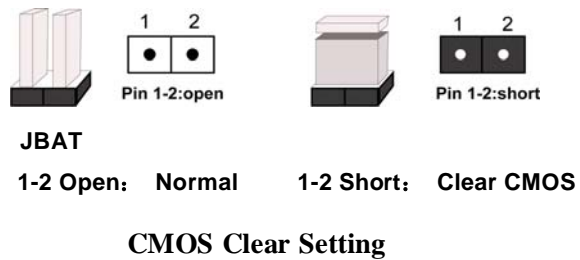
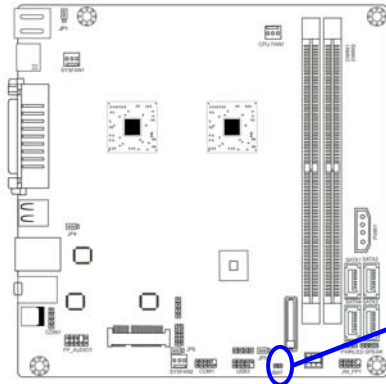

(2) KB/USB1 Power On Function Setting: JP1

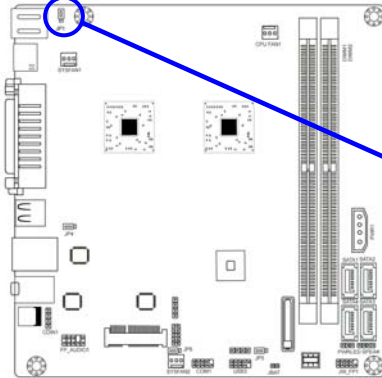

1-2 Closed: K.B&USB1 POWER-ON Disacted(default)

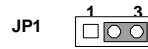

2-3 closed: K.B& USB1 POWER-ON Enabled

(3) USB Power On Function Setting: JP4

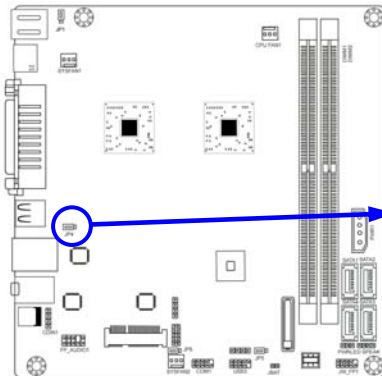

1-2 closed : USB POWER-ON Disacted(default)



2-3 closed: USB POWER-ON Enabled

(4) USB2/3 Power On Function Setting: JP5

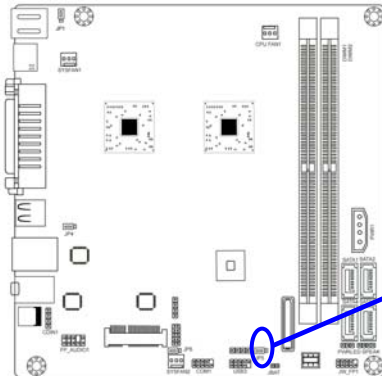

1-2 closed : USB2/3 POWER-ON Disacted(default)



2-3 closed: USB2/3 POWER-ON Enabled

(5) MINI PCIE Slot Power 3.3V/3.3VSB Select: JP6

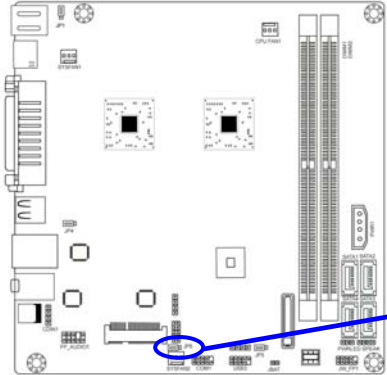

1-2 closed : MINI PCIE Slot Power 3.3V



2-3 closed: MINI PCIE Slot Power 3.3VSB

2-2 Connectors and Headers

2-2-1 Connectors

(1) Rear Panel Connectors

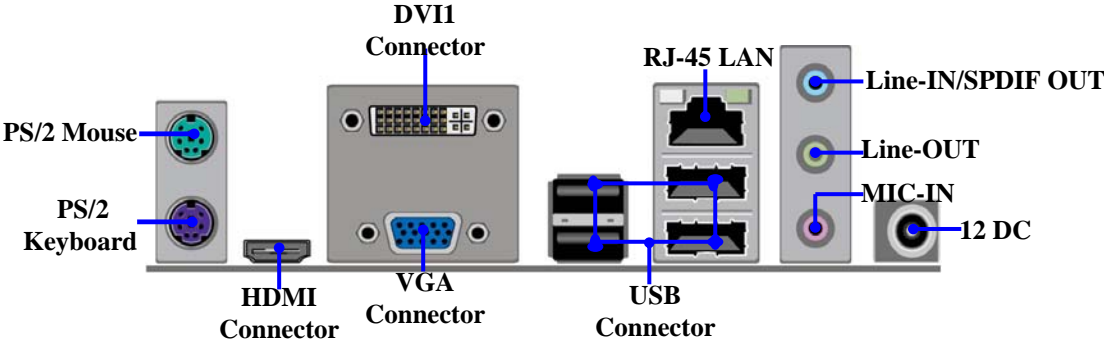

(2) Serial-ATAII Port connector: SATA1/SATA2/SATA3/SATA4

SATA 3/SATA4 support RAID 0, 1, JBOD function.

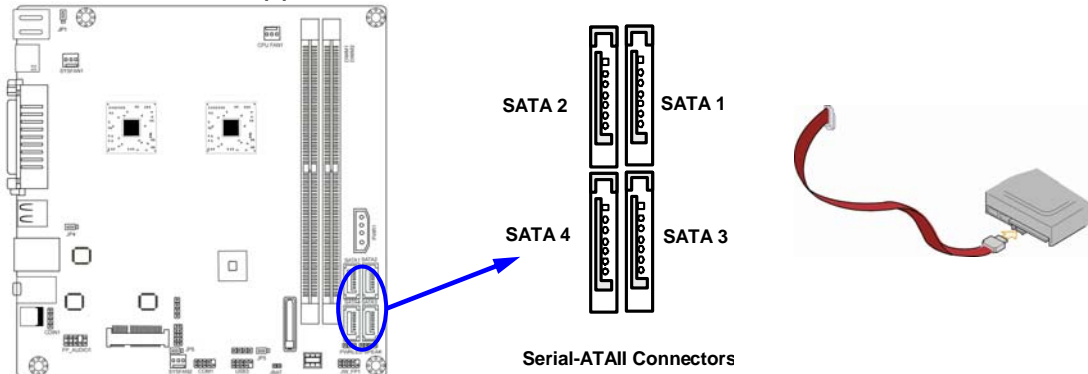

(3) Large 4-Pin Power Connector: PWR1

The connectors are 4-pin connector that supports extra 12V / 5V power to your system.

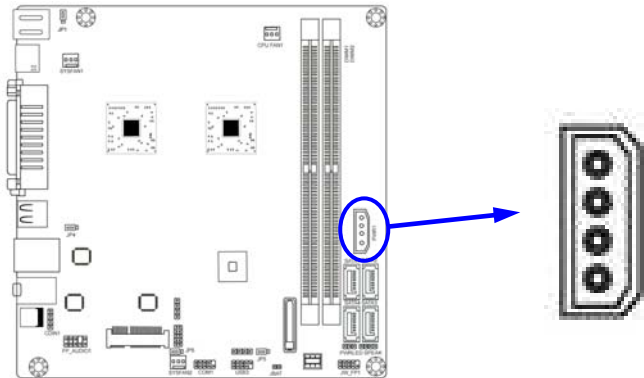

2-2-2 Headers

(1) Line-Out, MIC-In Header (9-pin): FP_AUDIO1 Header

This header connects to Front Panel Line-out, MIC-In connector with cable.

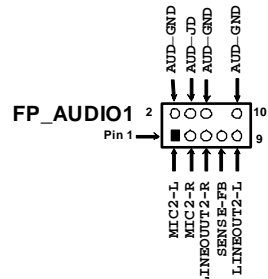
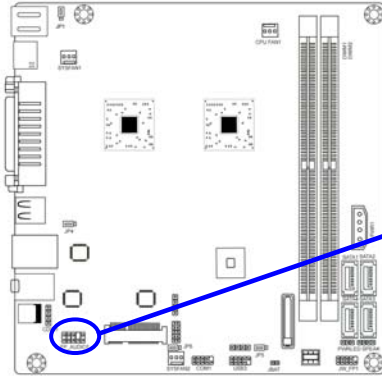

(2) CD AUDIO-In Headers (4-pin): CDIN1

CDIN are the connectors for CD-Audio Input signal. Please connect it to CD-ROM CD-Audio output connector.

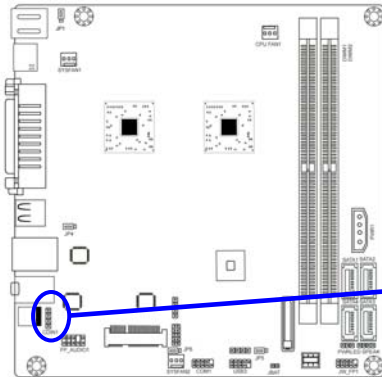

(3) Serial Port Connectors (9-Pin female): COM1

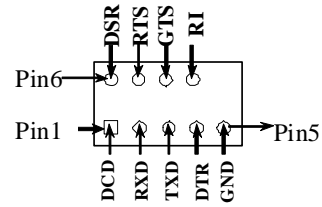
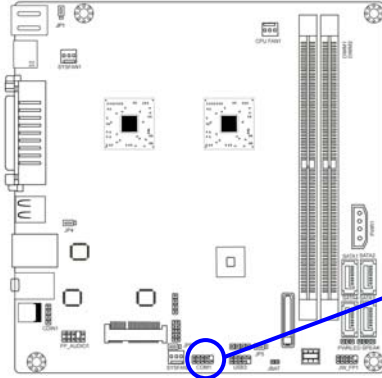

Serial COM Port 9-pin Block

(4) USB Port Headers (9-pin): USB3

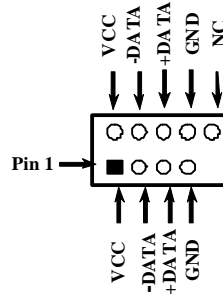
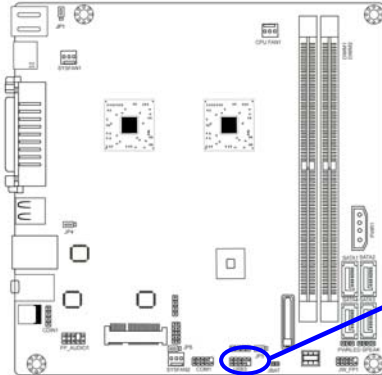

USB Port Header

(5) USB Port Headers (4-pin): USB2

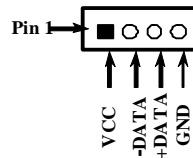
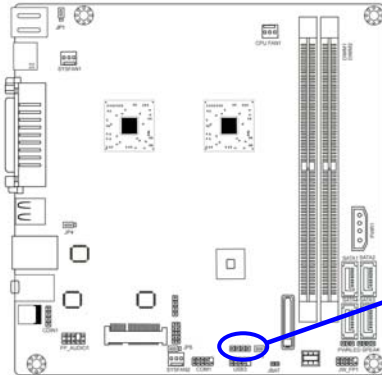

USB Port Header

(6) Speaker Header: SPEAK

This 4-pin header connects to the case-mounted speaker. See the figure below.

(7) Power LED: PWR LED

The Power LED is light on while the system power is on. Connect the Power LED from the system case to this pin.

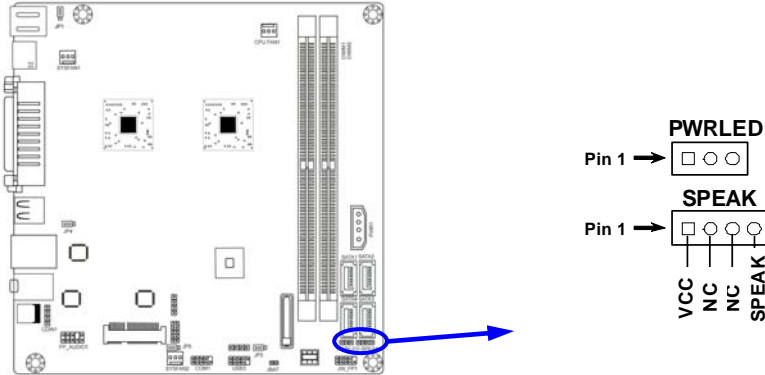

(8) Front Panel Header: JW-FP

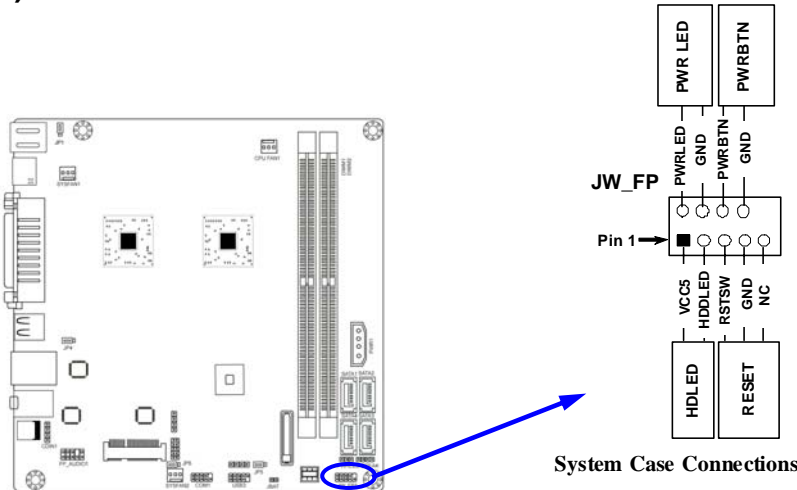

(9) FAN Speed Headers (3-pin): CPUFAN1, SYSFAN1/SYSFAN2

Pin1: GND

Pin2: +12V fan power

Pin3: Fan Speed

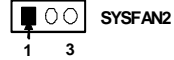
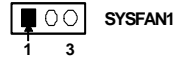
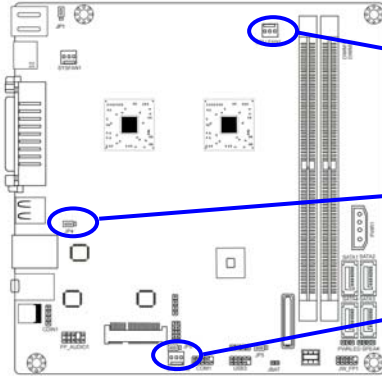

(10) GPIO Header (10-pin): GPIO_CON

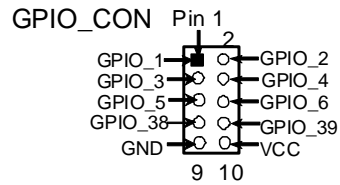
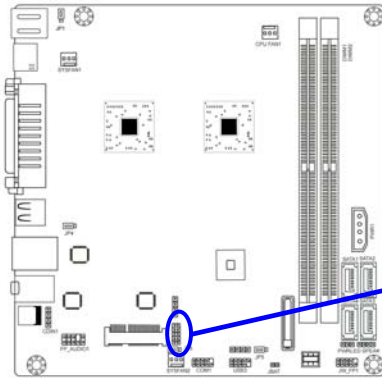

GPIO_CON Header

(11) CIR Header: CIR

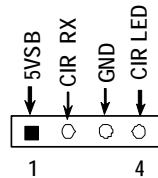
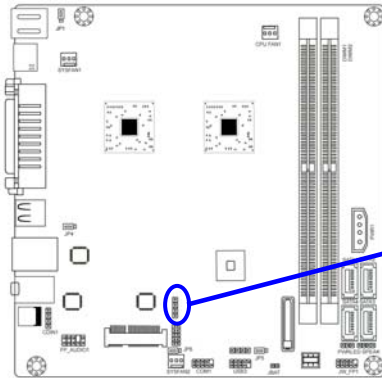

CIR Header

Chapter 3

Introducing BIOS

Notice! The BIOS options in this manual are for reference only. Different configurations may lead to difference in BIOS screen and BIOS screens in manuals are usually the first BIOS version when the board is released and may be different from your purchased motherboard. Users are welcome to download the latest BIOS version form our official website.

The BIOS is a program located on a Flash Memory on the motherboard. This program is a bridge between motherboard and operating system. When you start the computer, the BIOS program will gain control. The BIOS first operates an auto-diagnostic test called POST (power on self test) for all the necessary hardware, it detects the entire hardware device and configures the parameters of the hardware synchronization. Only when these tasks are completed done it gives up control of the computer to operating system (OS). Since the BIOS is the only channel for hardware and software to communicate, it is the key factor for system stability, and in ensuring that your system performance as its best.

In the BIOS Setup main menu of Figure 3-1, you can see several options. We will explain these options step by step in the following pages of this chapter, but let us first see a short description of the function keys you may use here:

- Press <Esc> to quit the BIOS Setup.
- Press ↑↓←→ (up, down, left, right) to choose, in the main menu, the option you want to confirm or to modify.
- Press <F10> when you have completed the setup of BIOS parameters to save these parameters and to exit the BIOS Setup menu.
- Press Page Up/Page Down or +/- keys when you want to modify the BIOS parameters for the active option.

3-1 Entering Setup

Power on the computer and by pressing immediately allows you to enter Setup. If the message disappears before you respond and you still wish to enter Setup, restart the system to try again by turning it OFF then ON or pressing the “RESET” button on the system case. You may also restart by simultaneously pressing <Ctrl>, <Alt> and <Delete> keys. If you do not press the keys at the correct time and the system does not boot, an error message will be displayed and you will again be asked to

Press to enter Setup

3-2 Getting Help

Main Menu

The on-line description of the highlighted setup function is displayed at the bottom of the screen.

Status Page Setup Menu/Option Page Setup Menu

Press F1 to pop up a small help window that describes the appropriate keys to use and the possible selections for the highlighted item. To exit the Help Window, press <Esc>.

3-3 The Main Menu

Once you enter AMI ® BIOS CMOS Setup Utility, the Main Menu (Figure 3-1) will appear on the screen. The Main Menu allows you to select from eleven setup functions and two exit choices. Use arrow keys to select among the items and press <Enter> to accept or enter the sub-menu.



Figure 3-1

Standard BIOS Features

Use this Menu for basic system configurations.

Advanced BIOS Features

Use this menu to set the Advanced Features available on your system.

Integrated Peripherals

Use this menu to specify your settings for integrated peripherals.

Power Management Setup

Use this menu to specify your settings for power management.

PnP/PCI Configurations

Use this menu to specify your settings for PnP and PCI configurations.

PC Health Status

This entry shows your PC health status.

Miscellaneous Control

Use this menu to specify your settings for Miscellaneous Control.

Load Optimized Defaults

Use this menu to load the BIOS default values these are setting for optimal performances system operations for performance use.

Load Standard Defaults

Use this menu to load the BIOS default values for the minimal/stable performance system operation

Set Supervisor Password

Use this menu to set supervisor password.

Set User Password

Use this menu to set user password.

Save & Exit Setup

Save CMOS value changes to CMOS and exit setup.

Exit Without Saving

Abandon all CMOS value changes and exit setup.

3-4 Standard BIOS Features

The items in Standard CMOS Setup Menu are divided into several categories. Each category includes no, one or more than one setup items. Use the arrow keys to highlight the item and then use the <PgUp> or <PgDn> keys to select the value you want in each item.

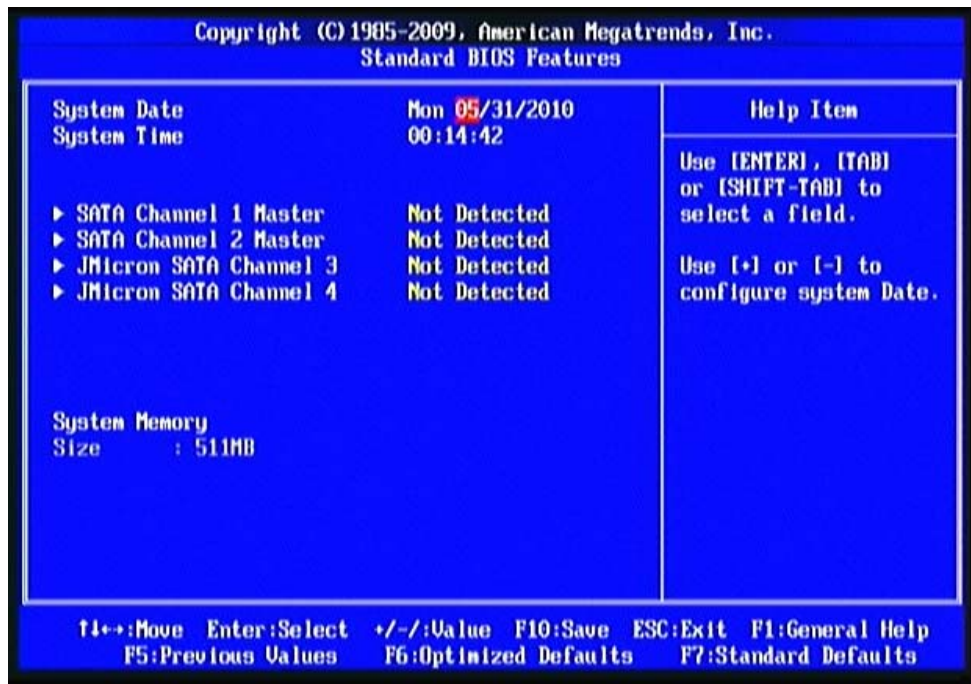

Date

The date format is <day><month><date><year>.

Day Day of the week is from Sun to Sat, determined by BIOS. Read-only.

Month The month is from Jan. through Dec.

Date The date from 1 to 31 can be keyed by numeric function keys.

Year The year depends on the year of the BIOS.

Time

The time format is <hour><minute><second>.

SATA Channel 1/2 Master

While entering setup, BIOS auto detects the presence of IDE devices. This displays the status of auto detection of IDE devices.

Type: The optional settings are: Not Installed; Auto; CD/DVD and ARMD. Use the item to select the type of device connected to the system.

LBA/Large Mode: The optional settings are Auto; Disabled.

Disabled: disables LBA mode.

Auto: enables LBA Mode if the devices support it and the device is not already formatted with LBA Mode disabled.

Block (Multi-Sector Transfer): The optional settings are: Disabled and Auto.

Disabled: The Data transfer from and to the device occurs one sector at a time.

Auto: The Data transfer from and to the device occurs multiple sectors at a time if the device supports it.

PIO Mode: the optional settings are: Auto, 0, 1, 2, 3 and 4. Use the item to select PIO mode

DMA MODE: the optional settings are Auto, SWDMAN, MWDMAN , UDMAN.

S.M.A.R.T.: This option allows you to enable the HDD S.M.A.R.T Capability (Self-Monitoring, Analysis and Reporting Technology). The optional settings are Auto; Disabled; and Eabled.

32 Bit Data Transfer: the optional settings are: Disabled; Enabled.

Enable/disable 32-bit data transfer.

JMicron SATA Channel 3/4

While entering setup, BIOS auto detects the presence of IDE devices. This displays the status of auto detection of IDE devices.

System Memory

This item will show information about the memory modules(s) installed.

3-5 Advanced BIOS Features

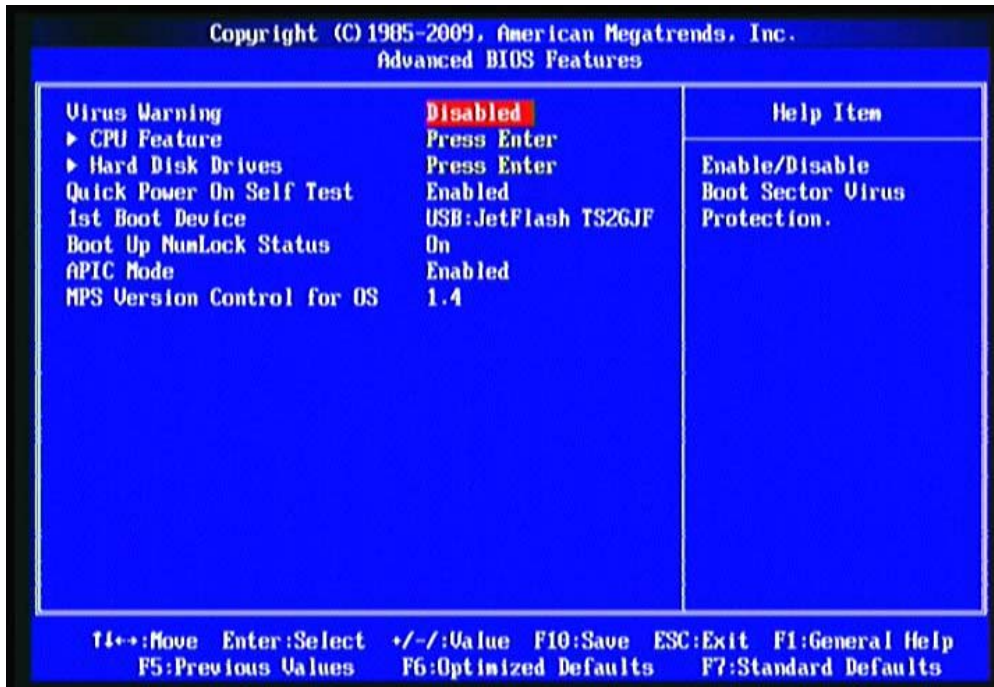

Virus Warning

The selection Allow you to choose the VIRUS Warning feature for IDE Hard Disk boot sector protection. If this function is enabled and someone attempt to write data into this area, BIOS will show a warning message on screen and alarm beep.

Disabled (default) No warning message to appear when anything attempts to access the boot sector or hard disk partition table.

Enabled Activates automatically when the system boots up causing a warning message to appear when anything attempts to access the boot sector of hard disk partition table.

Hard Disk Drives

Use the item to specify the boot device priority sequence from available hard driver.

Quick Power On Self Test

Allows BIOS to skip certain tests while booting. This will decrease the time needed to boot the system. The option setting is Disabled or Enabled.

1st Boot Devices

Specify the boot sequence from the available devices. A device enclosed in parenthesis has been disabled in corresponding type menu.

Boot Up NumLock Status

The default value is On.

On (default) Keypad is numeric keys.

Off Keypad is arrow keys.

APIC Mode

Include ACPI APIC table pointer to RSDT pointer list.

MPS Version Control for OS

This option is only valid for multiprocessor motherboards as it specifies the version of The Multiprocessor Specification (MPS) that the motherboard will use.

3-5-1 CPU Feature

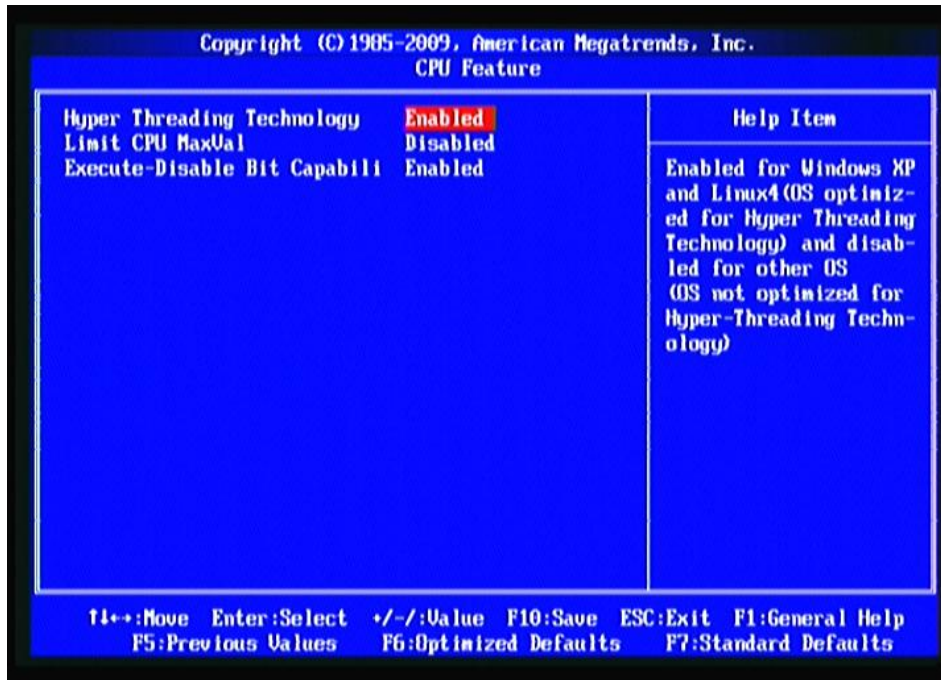

Hyper Threading Technology

Enabled for Windows XP and Linux4 (OS optimized for Hyper Threading Technology) and disabled for other OS (OS not optimized for Hyper –Threading Technology).

Limit CPU MaxVal

The optional settings are: Disabled; Enabled. Disabled for Windows XP.

Execute-Disable Bit Capabil

The optional settings are: Disabled; Enabled. When disabled, force the XD feature Flag to always return 0.

3-6 Integrated Peripherals

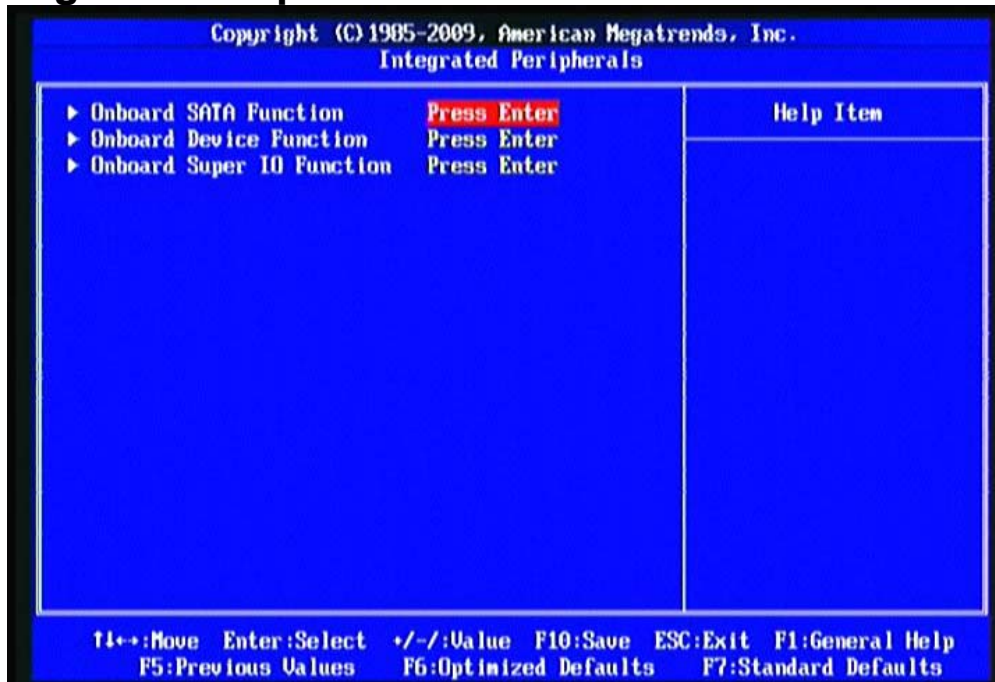

3-6-1 Onboard SATA Function



SATA Run Mode Configuration

The optional settings are: Compatible; Enhanced.

3-6-2 Onboard Device Function

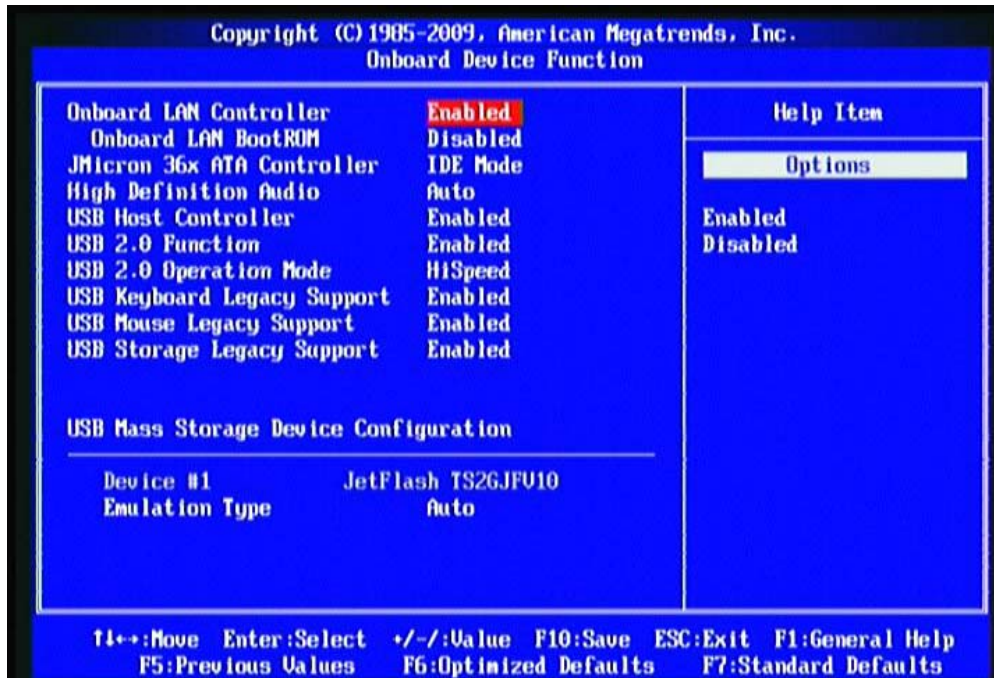

JMicron 36x ATA Controller

Use this item to select ATA Controller operate mode. The optional setting is Disabled; IDE Mode; RAID Mode; AHCI Mode.

High Definition Audio

This item allows you to decide to auto /disable the chipset family to support HD Audio. The optional settings are: Auto, Disabled.

USB 2.0 Operation Mode

The settings are: FullSpeed; HiSpeed. Use the item to configure the USB 2.0 controller in HiSpeed (480Mbps) or FullSpeed (12Mbps).

USB Keyboard/ Mouse/ Storage Legacy Support

Select enabled if your system contains a Universal Serial Bus (USB) controller and you have a USB keyboard /mouse/storage device. The settings are: Enabled, Disabled.

Emulation Type

If Auto, USB devices less then 530MB will be emulated as floppy and remaining as hard device. Forced FDD option can be used to force a HDD formatted drive to boot as FDD (Ex. ZIP Drive).

3-6-3 Onboard Super IO Function



Serial Port 1 Address

The optional settings are: Disabled, 3F8/IRQ4, 3E8/IRQ4, 2E8/IRQ3, 2F8/IRQ3. This item allows BIOS to select Serial Port1 Base Addresses.

CIR Address

Use this item to allow BIOS to select Serial Port2 base addresses. The optional setting is Disabled, 3F8/IRQ4, 3E8/IRQ4, 2E8/IRQ3, 2F8/IRQ3.

3-7 Power Management Setup

The Power Management Setup allows you to configure your system to most effectively save energy saving while operating in a manner consistent with your own style of computer use.

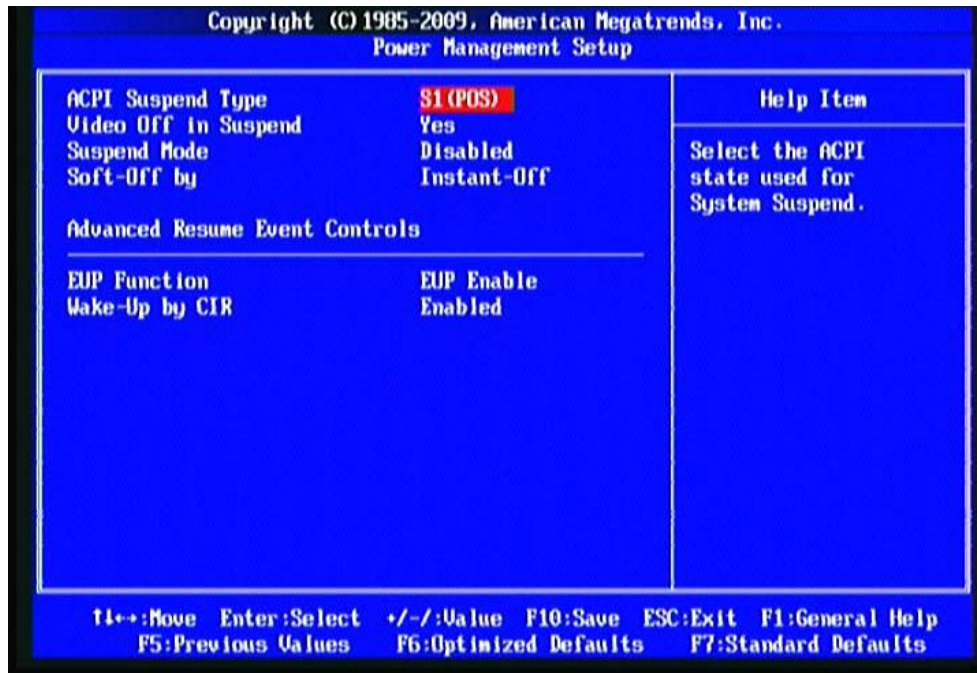

ACPI Suspend Type

Select the ACPI state used for System Suspend. The optional setting is S1 (POS) or S3 (STR).

Video Off in Suspend

The optional settings are: No; Yes.

Suspend Mode

Go into Suspend in the specified Time. The optional settings are: Disabled;1Min;2 Min;4 Min;8 Min;10 Min;20 Min;30 Min;40 Min;50 Min;60 Min.

Soft-Off by

Go into On/Off, or Suspend when Power button is pressed.

ERP (EUP) Function

The options are Disabled; EUP Enabled; CIR Wake-Up mode.

3-8 PnP/PCI Configurations



IRQ Resources

Names the interrupt request (IRQ) line assigned to the USB on your system. Activity of the selected IRQ always awakens the system.

PCI/VGA Palette Snoop

The options are Disabled or Enabled. Enabled: informs the PCI devices that an ISA graphics device is installed in the system so the card will function correctly.

3-9 PC Health Status

This section shows the Status of your CPU, Fan, and Warning for overall system status. This is only available if there is Hardware Monitor onboard.

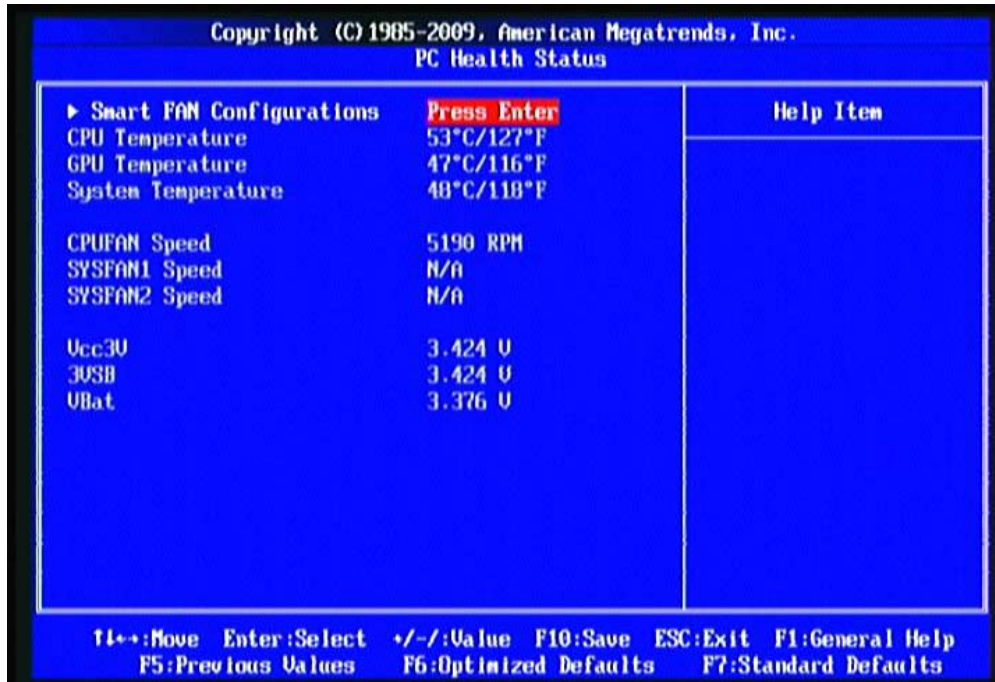

Copyright (C) 1985-2009, American Megatrends, Inc.
PC Health Status

▶ Smart FAN Configurations	Press Enter	Help Item
CPU Temperature	53°C/127°F	
GPU Temperature	47°C/116°F	
System Temperature	48°C/118°F	
CPUFAN Speed	5190 RPM	
SYSFAN1 Speed	N/A	
SYSFAN2 Speed	N/A	
Vcc3V	3.424 V	
3VSB	3.424 V	
VBat	3.376 V	

T1←→:Move Enter:Select +/=:Value F10:Save ESC:Exit F1:General Help
F5:Previous Values F6:Optimized Defaults F7:Standard Defaults

Smart Fan Configuration

Press Enter to set certain values for the following three items: CPUFAN Smart Mode; SFAN1 Smart Mode; SFAN2 Smart Mode.

CPU Temperature/GPU Temperature/System Temperature/CPUFAN Speed/SYSFAN1 Speed/SYSFAN2 Speed/Vcc3V/3VSB/VBat

This will show the CPU/FAN/System voltage chart and FAN Speed, etc.

3-9-1 Smart FAN Configurations

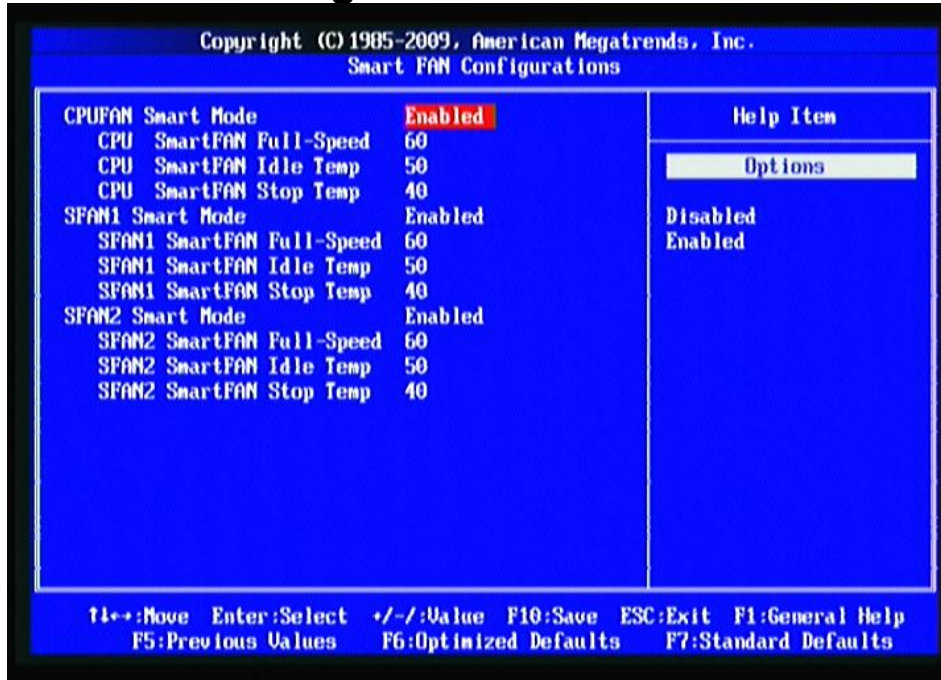

CPU/ SFAN1/SYSFAN2 SmartFAN Full-Speed

The optional range is 51~80, Fan will full speed when above this temperature.

CPU/ SFAN1/SYSFAN2 SmartFAN Idle Temp

The optional range is 41~50, Fan will low speed when below this temperature.

CPU/ SFAN1/SYSFAN2 SmartFAN Stop Temp

The optional range is 0~40, Fan stop when below this temperature.

3-10 Miscellaneous Control

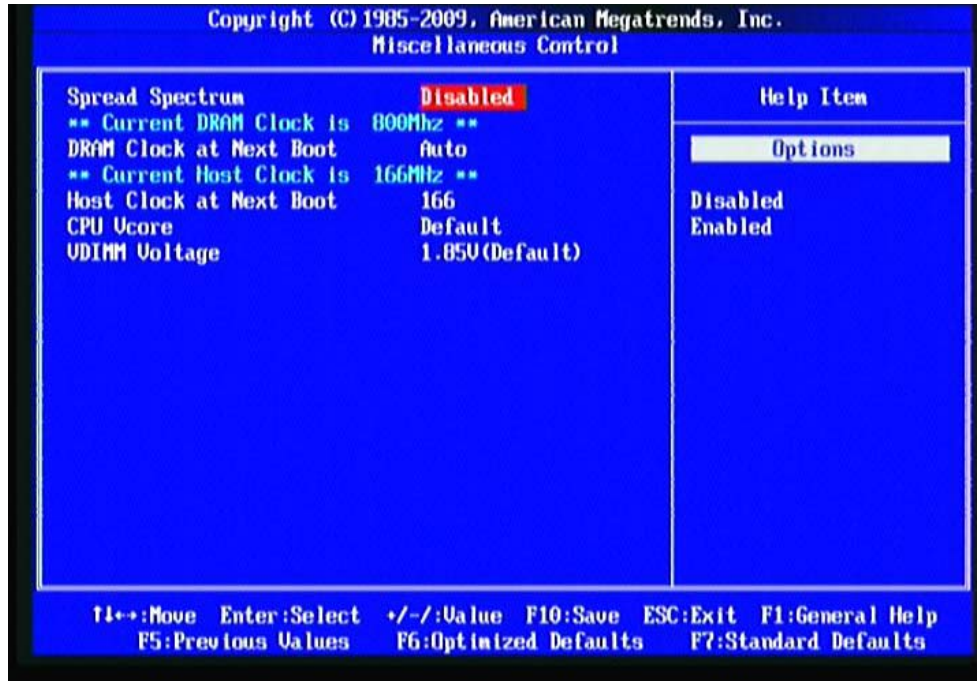

Spread Spectrum

The optional settings are: Enabled; Disabled.

DRAM Clock at Next Boot

This item allows you to set DRAM clock. The optional settings are: Auto; 667MHz; 800MHz.

Host Clock at Next Boot

Use the item to set CPU Frequency.

CPU Vcore

The optional settings are: default; +50mV; +100mV; +150mV.

VDIMM Voltage

The optional settings are: 1.85V (Default); 1.90V; 1.95V; 2.00V.

3-11 Password Setting

You can set either supervisor or user password, or both of them. The differences are:

Supervisor password: Can enter and change the options of the setup menus.

User password: Can only enter but do not have the right to change the options of the setup menus. When you select this function, the following message will appear at the center of the screen to assist you in creating a password.

ENTER PASSWORD:

Type the password, up to eight characters in length, and press <Enter>. The password typed now will clear any previously entered password from CMOS memory. You will be asked to confirm the password. Type the password again and press <Enter>. You may also press <Esc> to abort the selection and not enter a password. To disable a password, just press <Enter> when you are prompted to enter the password. A message will confirm that the password will be disabled. Once the password is disabled, the system will boot and you can enter Setup freely.

PASSWORD DISABLED.

When a password has been enabled, you will be prompted to enter it every time you try to enter Setup. This prevents an unauthorized person from changing any part of your system configuration.

Additionally, when a password is enabled, you can also require the BIOS to request a password every time your system is rebooted. This would prevent unauthorized use of your computer.

You determine when the password is required within the BIOS Features Setup Menu and its Security option. If the Security option is set to "System", the password will be required both at boot and at entry to Setup. If set to "Setup", prompting only occurs when trying to enter Setup.

3-12 Load Optimized /Standard Defaults

Load Optimized Defaults

When you press <Enter> on this item, you get a confirmation dialog box with a message similar to:

```
Load Optimized Defaults?  
【OK】      【Cancel】
```

Pressing <OK> loads the default values that are factory settings for optimal performance system operations.

Load Standard Defaults

When you press <Enter> on this item, you get a confirmation dialog box with a message similar to:

```
Load Standard Defaults?  
【OK】      【Cancel】
```

Pressing <OK> loads the default values that are factory settings for stable performance system operations.

3-13 Save and Exit Setup/ Exit Without Saving

Save and Exit Setup

When you press <Enter> on this item, you get a confirmation dialog box with a message similar to:

```
Save configuration changes and exit setup?  
【OK】      【Cancel】
```

Pressing <OK> save the values you made previously and exit BIOS setup.

Exit Without Saving

When you press <Enter> on this item, you get a confirmation dialog box with a message similar to:

```
Discard Changes and Exit Setup?  
【OK】      【Cancel】
```

Pressing <OK> to leave BIOS setting without saving previously set values.