

TECHNICAL MANUAL
Of
Intel Pine Trail D & NM10 Chipset
Based
Mini-ITX M/B for ATOM Processor

NO. G03-NC9M-F

Revision: 1.0

Release date: February, 2012

Trademark:

* Specifications and Information contained in this documentation are furnished for information use only, and are subject to change at any time without notice, and should not be construed as a commitment by manufacturer.

Environmental Protection Announcement

Do not dispose this electronic device into the trash while discarding. To minimize pollution and ensure environment protection of mother earth, please recycle.



TABLE OF CONTENT

ENVIRONMENTAL SAFETY INSTRUCTION.....	iii
USER'S NOTICE	iv
MANUAL REVISION INFORMATION.....	iv
ITEM CHECKLIST	iv
CHAPTER 1 INTRODUCTION OF THE MOTHERBOARD	
1-1 FEATURE OF MOTHERBOARD.....	1
1-2 SPECIFICATION	2
1-3 LAYOUT DIAGRAM.....	3
CHAPTER 2 HARDWARE INSTALLATION	
2-1 JUMPER SETTING	8
2-2 CONNECTORS AND HEADERS.....	11
2-2-1 CONNECTORS	11
2-2-2 HEADERS	13
CHAPTER 3 INTRODUCING BIOS	
3-1 ENTERNING SETUP.....	21
3-2 GETTING HELP	21
3-3 THE MAIN MENU.....	21
3-4 STANDARD BIOS FEATURES	23
3-5 ADVANCED BIOS FEATURES	25
3-5-1 CPU FEATURE	27
3-6 ADVANCED CHIPSET FEATURES	27
3-7 INTEGRATED PHERIPHRALS	29
3-7-1 ONBOARD SATA FUNCTION	30
3-7-2 ONBOARD DEVICE FUNCTION.....	31
3-7-3 ONBOARD SUPER IO FUNCTION.....	32
3-8 POWER MANAGEMENT SETUP.....	33
3-9 PNP/PCI CONFIGURATIONS.....	35
3-10 PC HEALTH STATUS.....	35
3-11 MISCELLANEOUS CONTROL.....	37
3-12 PASSWORD SETTING	38
3-13 LOAD OPTIMIZED /STANDARDDEFAULTS	39
3-14 SAVE AND EXIT SETUP/EXIT WITHOUT SAVING	39



Environmental Safety Instruction

- Avoid the dusty, humidity and temperature extremes. Do not place the product in any area where it may become wet.
- 0 to 60 centigrade is the suitable temperature. (The figure comes from the request of the main chipset)
- Generally speaking, dramatic changes in temperature may lead to contact malfunction and crackles due to constant thermal expansion and contraction from the welding spots' that connect components and PCB. Computer should go through an adaptive phase before it boots when it is moved from a cold environment to a warmer one to avoid condensation phenomenon. These water drops attached on PCB or the surface of the components can bring about phenomena as minor as computer instability resulted from corrosion and oxidation from components and PCB or as major as short circuit that can burn the components. Suggest starting the computer until the temperature goes up.
- The increasing temperature of the capacitor may decrease the life of computer. Using the close case may decrease the life of other device because the higher temperature in the inner of the case.
- Attention to the heat sink when you over-clocking. The higher temperature may decrease the life of the device and burned the capacitor.

USER'S NOTICE

COPYRIGHT OF THIS MANUAL BELONGS TO THE MANUFACTURER. NO PART OF THIS MANUAL, INCLUDING THE PRODUCTS AND SOFTWARE DESCRIBED IN IT MAY BE REPRODUCED, TRANSMITTED OR TRANSLATED INTO ANY LANGUAGE IN ANY FORM OR BY ANY MEANS WITHOUT WRITTEN PERMISSION OF THE MANUFACTURER.

THIS MANUAL CONTAINS ALL INFORMATION REQUIRED TO USE THIS MOTHER-BOARD SERIES AND WE DO ASSURE THIS MANUAL MEETS USER'S REQUIREMENT BUT WILL CHANGE, CORRECT ANY TIME WITHOUT NOTICE. MANUFACTURER PROVIDES THIS MANUAL "AS IS" WITHOUT WARRANTY OF ANY KIND, AND WILL NOT BE LIABLE FOR ANY INDIRECT, SPECIAL, INCIDENTAL OR CONSEQUENTIAL DAMAGES (INCLUDING DAMAGES FOR LOSS OF PROFIT, LOSS OF BUSINESS, LOSS OF USE OF DATA, INTERRUPTION OF BUSINESS AND THE LIKE).

PRODUCTS AND CORPORATE NAMES APPEARING IN THIS MANUAL MAY OR MAY NOT BE REGISTERED TRADEMARKS OR COPYRIGHTS OF THEIR RESPECTIVE COMPANIES, AND THEY ARE USED ONLY FOR IDENTIFICATION OR EXPLANATION AND TO THE OWNER'S BENEFIT, WITHOUT INTENT TO INFRINGE.

Manual Revision Information

Reversion	Revision History	Date
1.0	First Edition	February, 2012

Item Checklist

- Motherboard
- User's Manual
- DVD for motherboard utilities
- Cable(s)
- I/O Back panel shield

Chapter 1

Introduction of the Motherboard

1-1 Feature of Motherboard

- Intel Pine Trail-D and NM10 chipset, with low power consumption never denies high performance
- Support two DDRIII SODIMM 800 MHz up to 4GB
- Support 2 * Serial ATAII (3Gb/s) Devices
- Onboard dual Realtek RTL 8111EVL Gigabit Ethernet LAN chip
- Integrated ALC662 6-channel HD audio CODEC
- Support USB 2.0 data transport demands
- Support RS232/422/485
- Support PCI slot and Mini-PCIE slot
- Support CPU Smart FAN
- Supports ACPI S3 Function
- Support Watchdog function

1-2 Specification

Spec	Description
Design	● Mini-ITX form factor; PCB size: 17.0x17.0cm
Chipset	● Intel® NM10 Express chipset
Embedded CPU	● Intel Atom CPU
Memory Socket	● DDRIII SODIMM slot x2 ● Support two DDRIII 800 MHz SO-DIMM with memory capacity expandable to 4GB
Expansion Slot	● 32-bit PCI slot x 1 ● Mini-PCIE slot x1
Dual LAN Chip	● Integrated with two Realtek RTL8111EVL PCI-E Gigabit LAN chips ● Support Fast Ethernet LAN function of providing 10/100/1000Mbps Ethernet data transfer rate
Audio Chip	● Realtek ALC662 6-channel Audio Codec integrated ● Audio driver and utility included
BIOS	● AMI 8MB DIP Flash ROM
Multi I/O	● PS/2 keyboard port x1 ● PS/2 mouse port x1 ● Parallel port x1 ● Serial port x1 ● VGA port x1 ● RJ-45 LAN connector x2 ● USB 2.0 port x4 ● Audio connector x3 (Line-in, Line-out, MIC) ● SATAII x2 ● Serial port header x5 ● RS422/RS485 header x1 ● 4-pin USB 2.0 header x1 ● 9-pin USB 2.0 header x1 ● LVDS header x1 and LVDS inverter x1 ● GPIO header x1

- Front panel audio header x1
- Speaker header x1
- HDMI_SPDIF header x1
- UL1_LED header x1
- UL2_LED header x1
- PWRLED header x1
- Front panel header x1

1-3 Layout Diagram

Rear IO Diagram

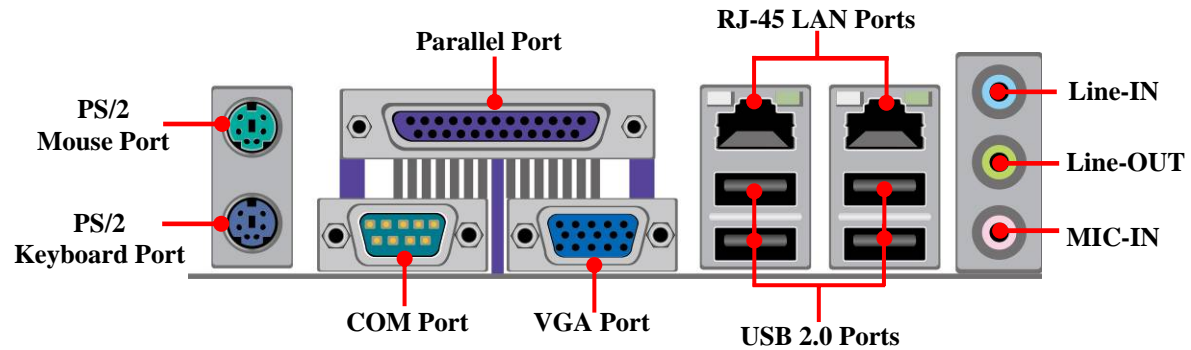

Motherboard Internal Diagram

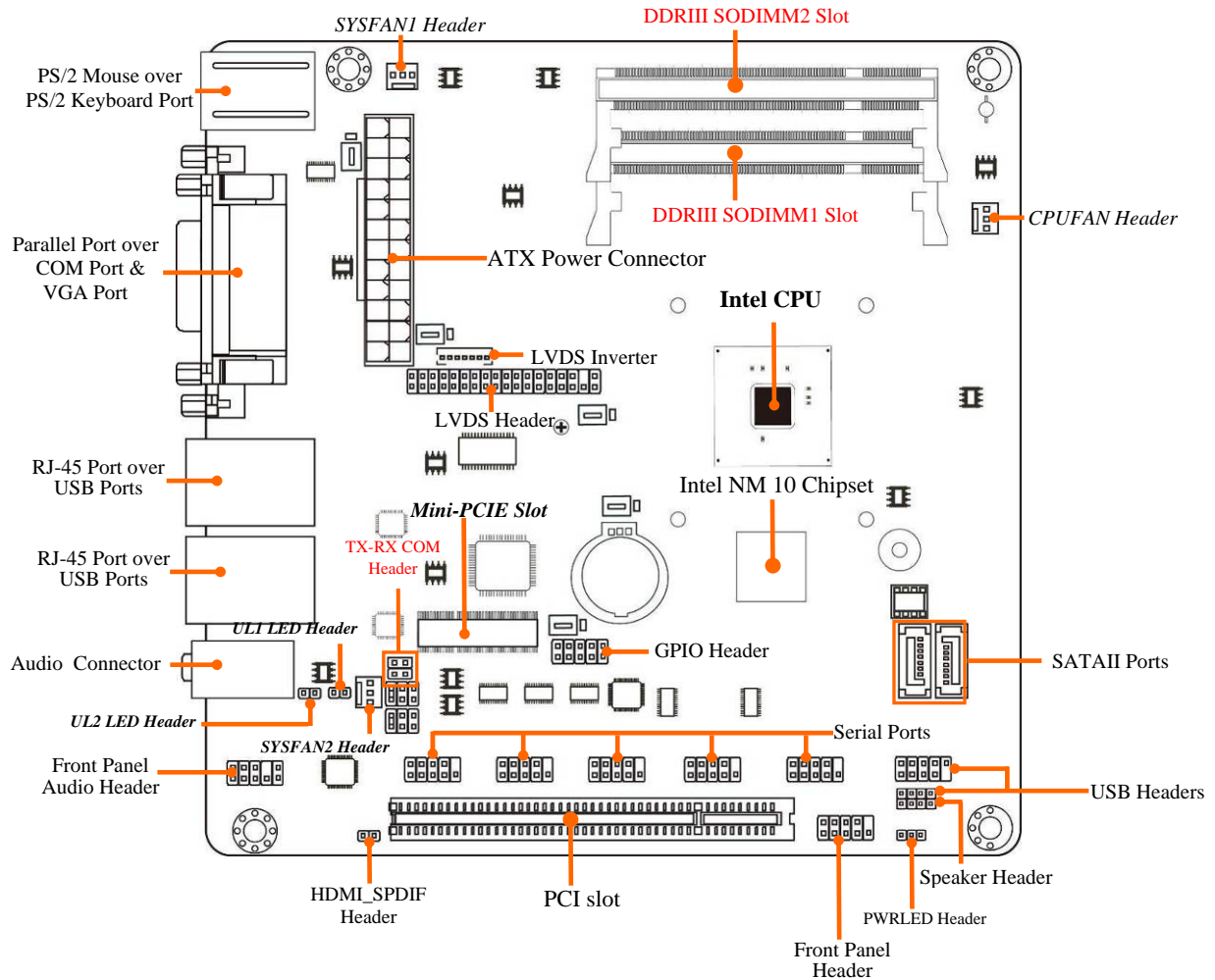

Motherboard Jumper Position

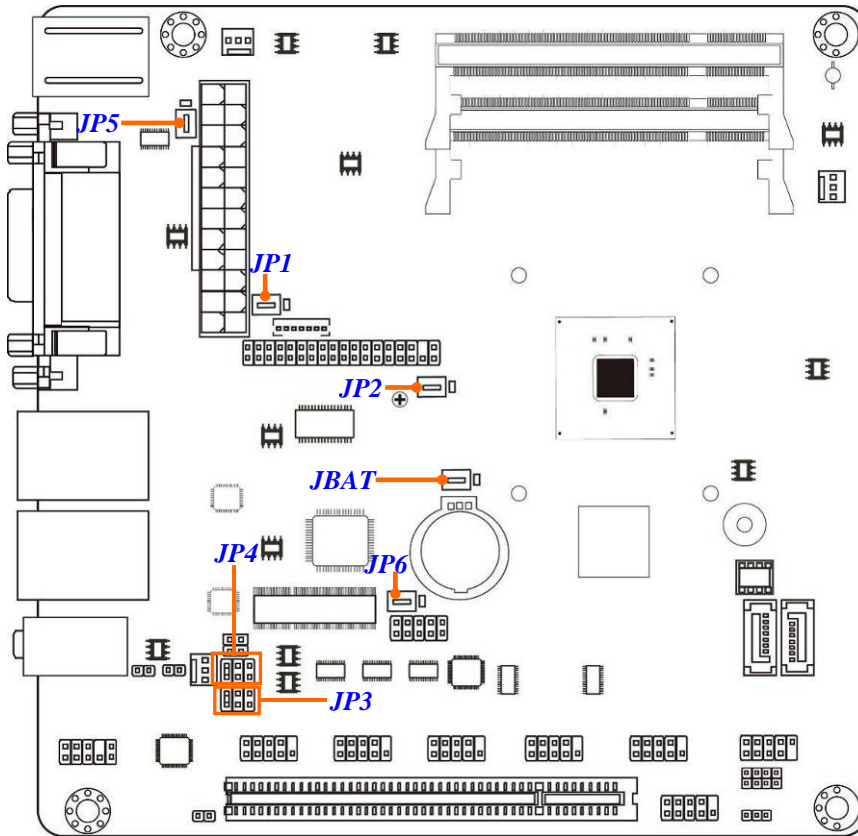

Jumper

Jumper	Name	Description
JBAT	CMOS RAM Clear Function Setting	3-pin Block
JP1	Inverter12V/5V Select	3-pin Block
JP2	LVDS PVCC 5V/3.3V Select	3-pin Block
JP3	COM2 Header RS232 Power Select	6-pin Block
JP4	COM2 Header RS232/485 /422Function Select	6-pin Block
JP5	KB/MS Power On Function Setting	3-pin Block
JP6	MINIPCIE Power SB 3.3V/3.3V Select	3-pin Block

Connectors

Connector	Name	Description
ATXPWR	ATX Power Connector	24-pin Block
KB(from KBMS)	PS2 Keyboard Connector	6-pin Female
MS(from KBMS)	PS2 Mouse Connector	6-pin Female
COM1	Serial Port Connector	9-pin Connector
VGA	Video Graphic Attach Connector	15-pin Connector
PARALLEL1	Parallel Port Connector	25-pin Connector
LAN (from UL1/UL2)	RJ-45 LAN Connector	8-pin Connector
USB (from UL1/UL2)	USB 2.0 Port	4-pin Connector
AUDIO	Line Out /Line In /MIC Audio Connector	3-phone Jack
SATA1/SATA2	Serial ATAll Connectors	7-pin Connector

Headers

Header	Name	Description
FP_AUDIO	Front panel audio Header	9-pin Block
COM2/COM3/ COM4/COM5/COM6	Serial Port Header	9-pin Block
TX-RXCOM	RS422/485 port header	4-pin Block
USB2	USB 2.0 Header	9-pin Block
USB3	USB 2.0 Header	4-pin Block
SPEAK	Speaker Header	4-pin Block
PWRLED	Power LED	3-pin Block
JW_FP	Front Panel Header(PWR LED/ HD LED/ /Power Button /Reset)	9-pin Block
CPUFAN1/SYSFAN1/ SYSFAN2	FAN Speed Headers	3-pin Block
HDMI_SPDIF	SPDIF Out header	2-pin block
UL1_LED/UL2_LED	LAN 1/2 ACT LED header	2-pin block
GPIO	GPIO Header	10-pin Block
INVERTER	LVDS Inverter Connector	7-pin Block
LVDS	LVDS Header	35-pin Block

Chapter 2

Hardware Installation

2-1 Jumper Setting

(1) JBAT (3-pin): Clear CMOS Function Setting

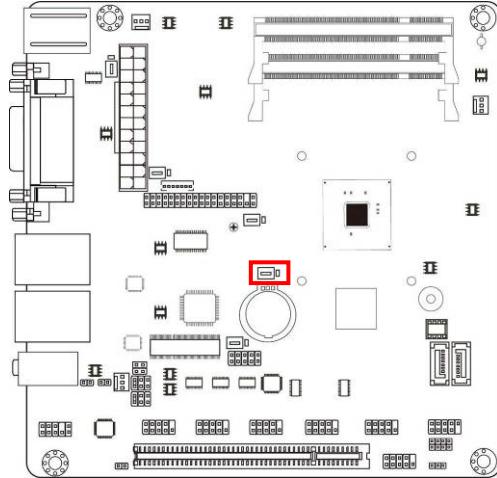

JBAT



1-2 closed: Normal;

JBAT



2-3 closed : Clear CMOS

(2) JP1 (3-pin): Inverter VCC 12V/5V select

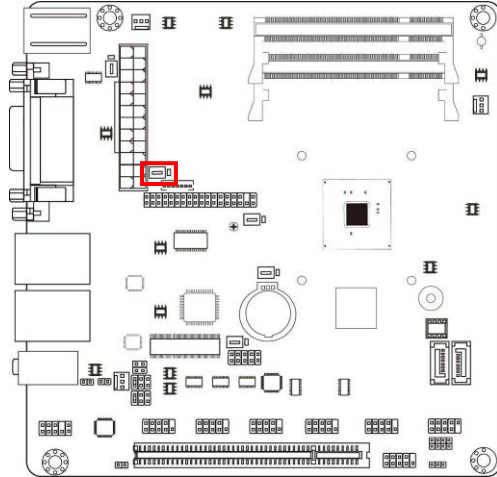

JP1



1-2 Closed: Inverter 12V Select;

JP1



2-3 Closed : Inverter 5V Select

(3) JP2 (3-pin): LVDS PVCC 5V/3.3V Select

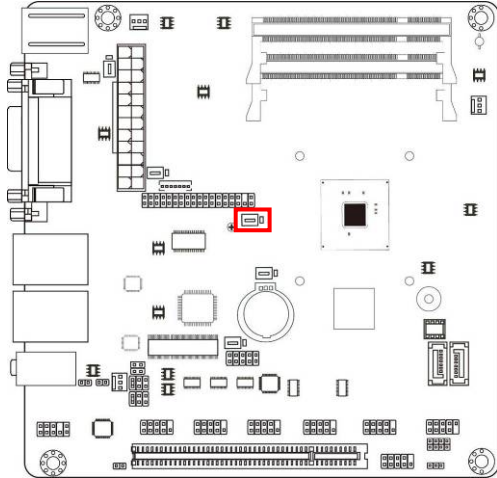

JP2



1-2 Closed: LVDS VCC= 5V;

JP2



2-3 Closed : LVDS VCC=3.3V

(4) JP3 (6-pin): COM2 Header RS232 Power Select

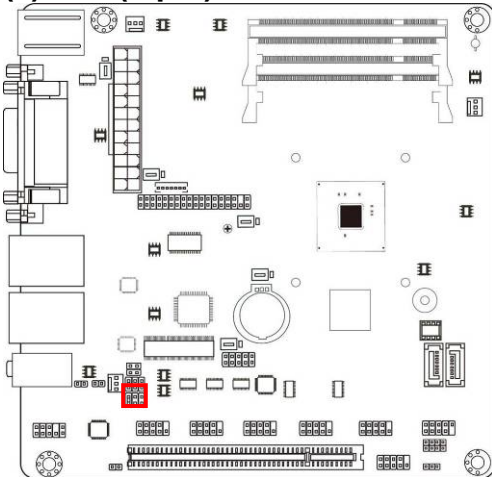

JP3

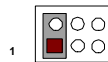

1-2 Closed: RS232;

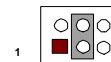

3-4 Closed : +12V;

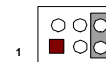

5-6 Closed : +5V

(5) JP4 (6-pin): COM2 Header RS232/485/422 Function Select

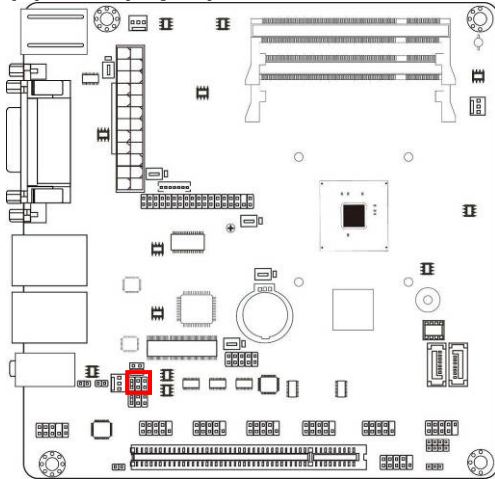

JP4

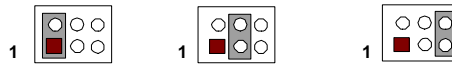

1-2 Closed: RS232; 3-4 Closed : RS485; 5-6 Closed : RS422

(6) JP5 (3-pin): KB/MS Power on Function Setting

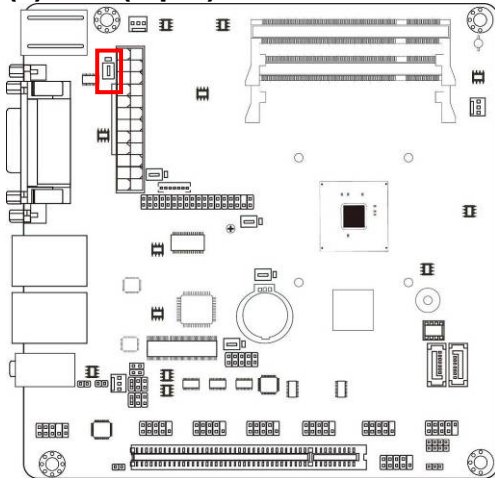

JP5



1-2 Closed: KB/MS Power-On Disabled(default)

JP5



2-3 Closed:KB/MS Power-On Enabled

(7) JP6 (3-pin): Mini PCI-E VCC3.3V/ SB3.3 V Select

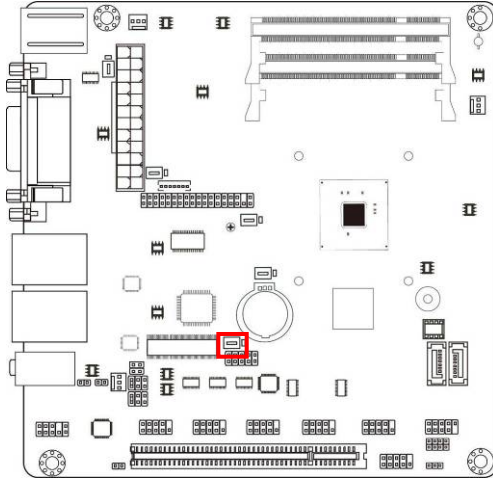

JP6



1-2 Closed : MINI PCI-E VCC= 3.3V Select;

JP6



2-3 Closed : MINI PCI-E VCC= SB3.3V Select

2-2 Connectors and Headers

2-2-1 Connectors

(1) I/O Panel Connector:

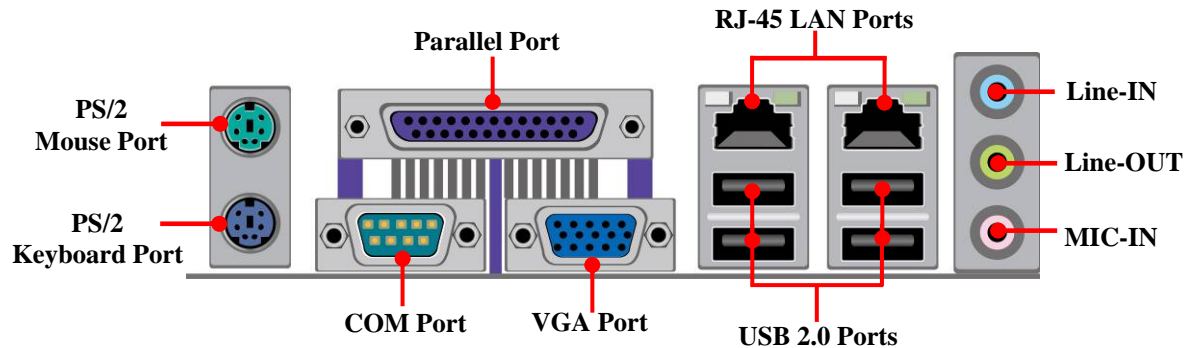

(2) SATA II Port connector: SATA1/SATA2

These connectors are high-speed SATAII ports that support 3 Gbps transfer rate.

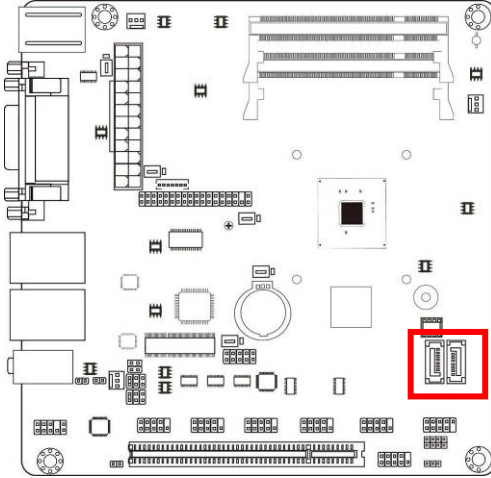

Pin No.	Definition
1	GND
2	TXP
3	TXN
4	GND
5	RXN
6	RXP
7	GND

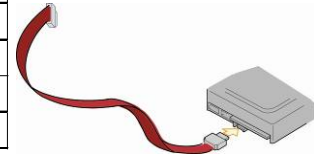

(3) Power Connector (24-pin block): AXPWR

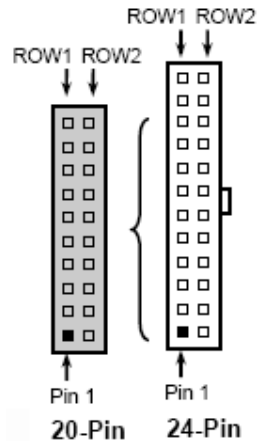
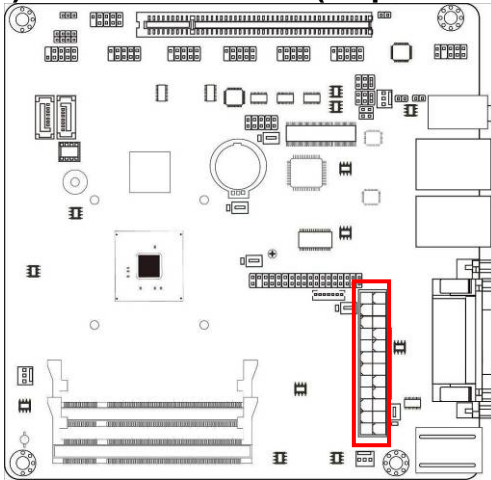

PIN	ROW1	ROW2
1	3.3V	3.3V
2	3.3V	-12V
3	GND	GND
4	5V	Soft Power On
5	GND	GND
6	5V	GND
7	GND	GND
8	Power OK	-5V
9	+5V (for Soft Logic)	+5V
10	+12V	+5V
11	+12V	+5V
12	+3V	GND

2-2-2 Headers

(1) FP_AUDIO (9-pin): Front Panel Audio Line-Out, MIC-In Header

This header connects to front panel Line-out, MIC-In connector with cable.

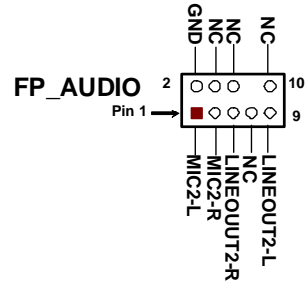
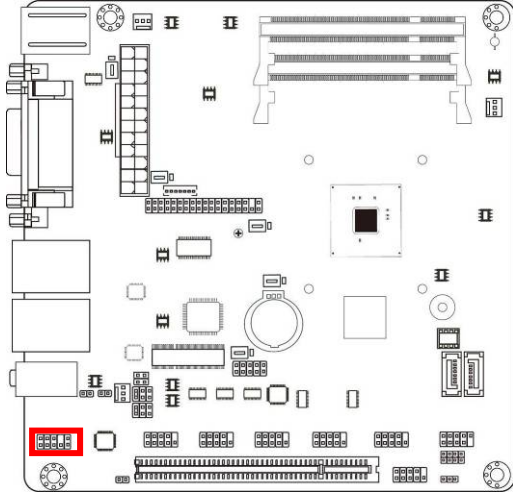

Line-Out, MIC Headers

(2) COM2/COM3/COM4/COM5/COM6 (9-Pin): Serial Port Header

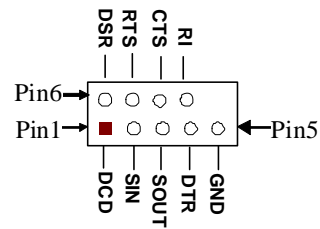
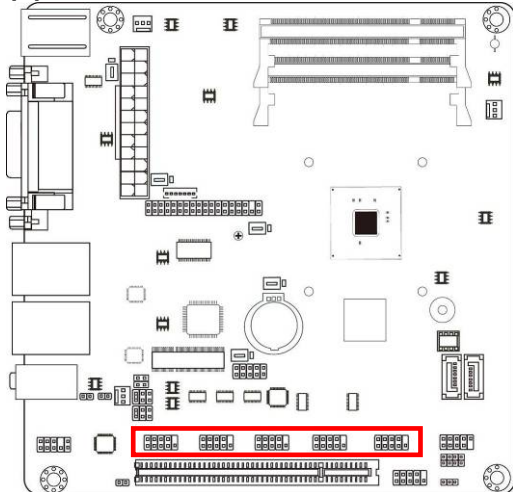

COM Port 9-pin Block

(3) TX-RXCOM (4-Pin): RS422/485 Header

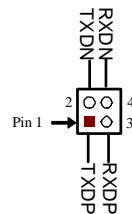
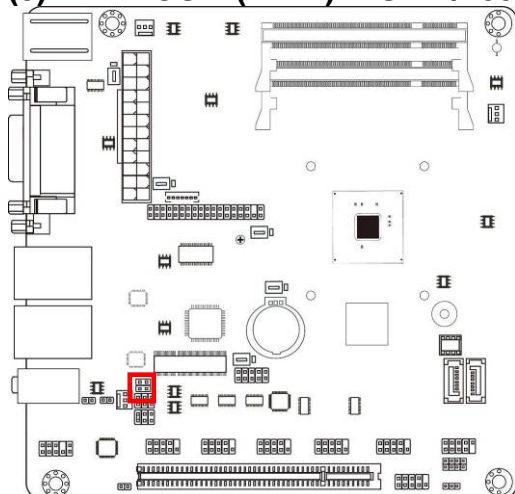

TX-RXCOM Header

(4) USB2 (9-pin): USB 2.0 Port Header

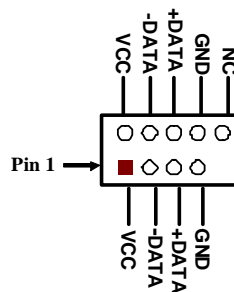
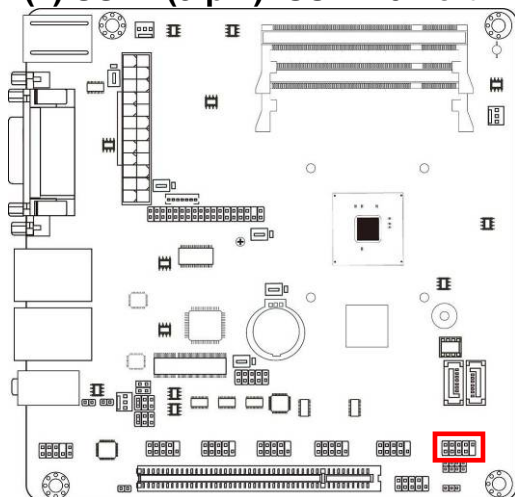

USB2 Header

(5) USB3 (4-pin):USB 2.0 Port Header

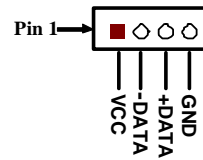
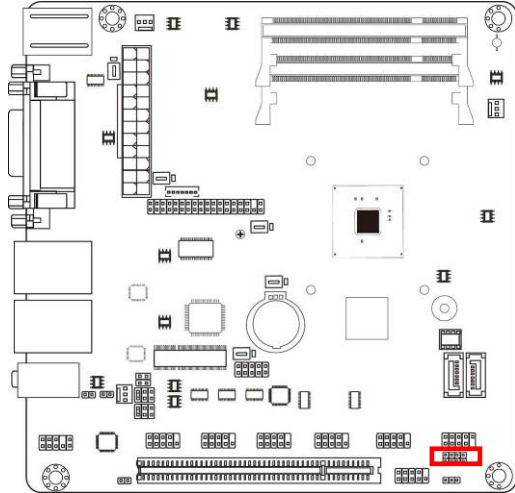

USB3 Header

(6) SPEAK (4-pin): Speaker Header

This 4-pin header is to connect the case-mounted speaker. See the figure below.

(7) PWRLED(3-pin): Power LED

The Power LED is light on while the system power is on. Connect the Power LED from the system case to this pin.

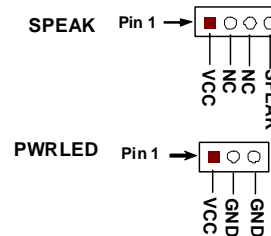
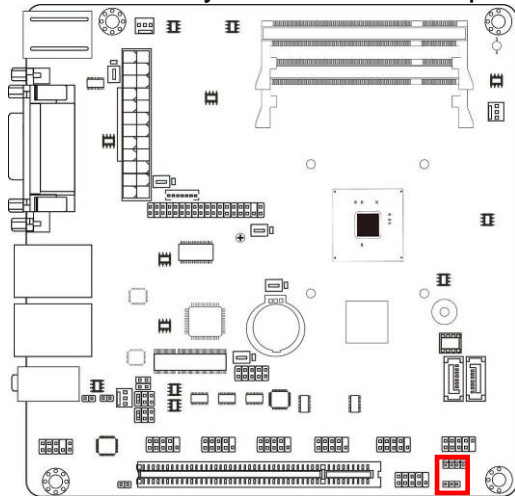

(8) JW-FP(9-pin): Front Panel Header

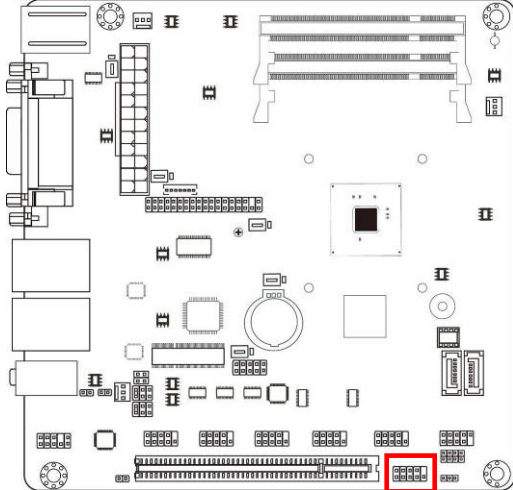

JW FP

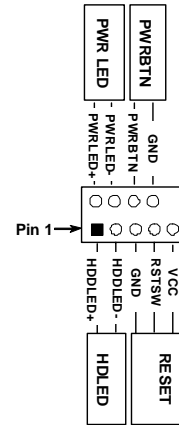

(9) CPUFAN1, SYSFAN1, SYSFAN2 (3-pin): FAN Speed Headers

Pin1: GND

Pin2: +12V fan power

Pin3: Fan Speed Detect

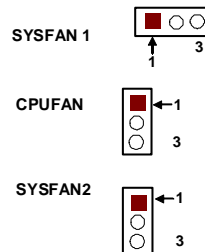
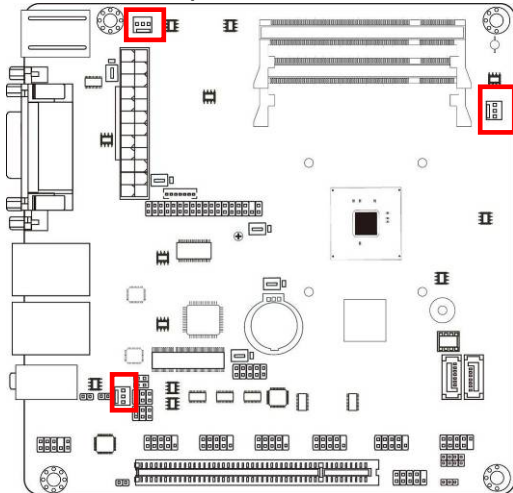

(10) HDMI_SPDIF (2-pin): HDMI-SPDIF Out header

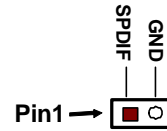
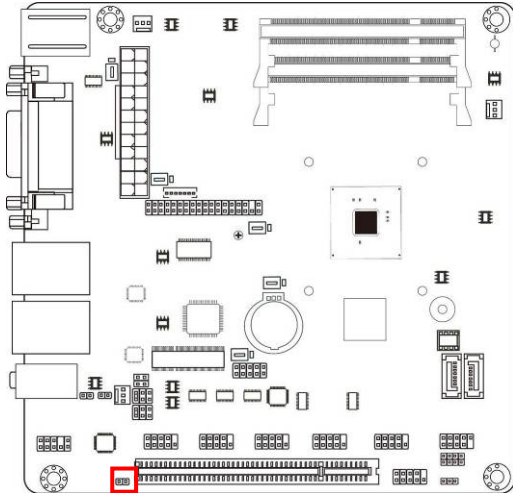

HDMI_SPDIF Header

(11) UL1_LED/UL2_LED (2-pin): LAN1/2 ACT LED

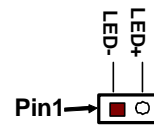
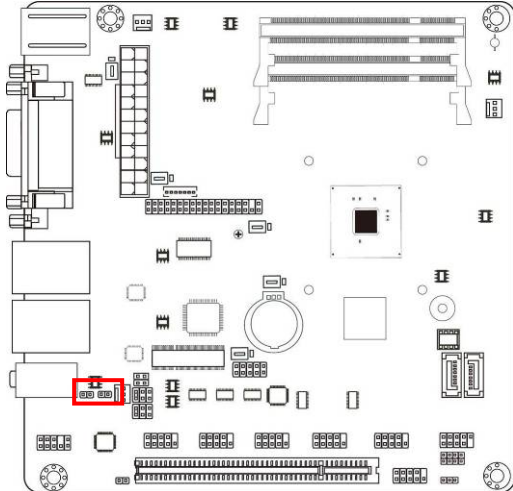

LAN 1/2 ACT LED

(12) GPIO_CON(10-pin): GPIO Header

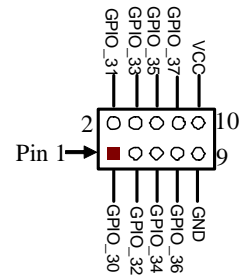
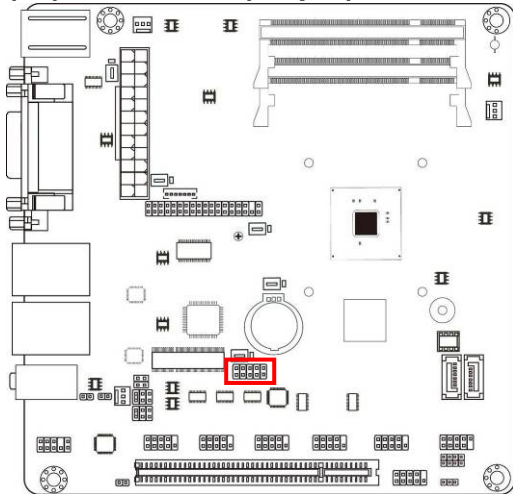

GPIO_CON Header

(13) INVERTER (7-Pin): LVDS Inverter

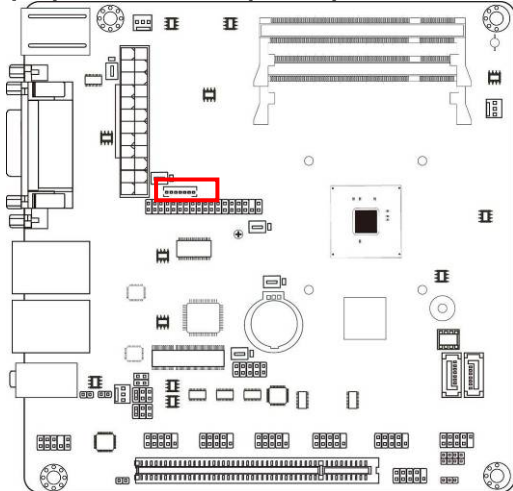

INVERTER

Pin No.	Definition
1	VCC
2	VCC
3	GND
4	GND
5	Backlight
6	GND
7	Brightness

(14) LVDS (35 Pin): LVDS Header

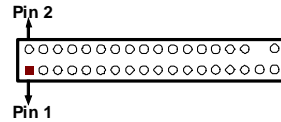
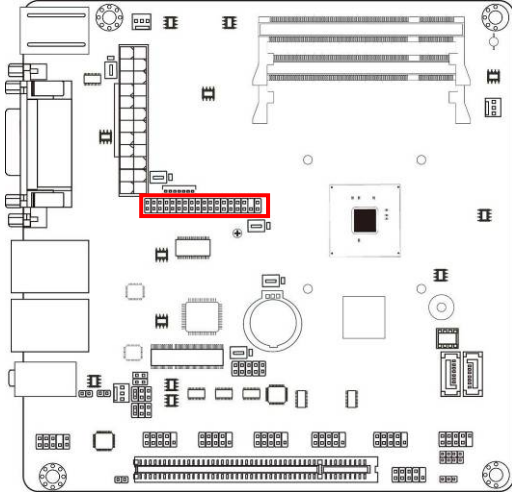

LVDS Header

Pin NO.	Pin Define	Pin NO.	Pin Define
Pin 1	NC	Pin 2	NC
Pin 3	NC	Pin 4	NC
Pin 5	NC	Pin 6	NC
Pin 7	NC	Pin 8	NC
Pin 9	NC	Pin 10	NC
Pin 11	LVDS_DDC_DATA	Pin 12	LVDS_DDC_CLK
Pin 13	GND	Pin 14	GND
Pin 15	GND	Pin 16	GND
Pin 17	NC	Pin 18	NC
Pin 19	LVDS_CLKAP	Pin 20	LVDS_CLKAN
Pin 21	LVDSA_DATAP2	Pin 22	LVDSA_DATAN2
Pin 23	LVDSA_DATAP1	Pin 24	LVDSA_DATAN1
Pin 25	LVDSA_DATAP0	Pin 26	LVDSA_DATAN0
Pin 27	PVDD	Pin 28	PVDD
Pin 29	PVDD	Pin 30	PVDD
Pin 31	GND	Pin 32	GND
Pin 33	+5V	Pin 34	N/A
Pin 35	+12V (Reserved)	Pin 36	+3V

Chapter 3

Introducing BIOS

Notice! The BIOS options in this manual are for reference only. Different configurations may lead to difference in BIOS screen and BIOS screens in manuals are usually the first BIOS version when the board is released and may be different from your purchased motherboard. Users are welcome to download the latest BIOS version form our official website.

The BIOS is a program located on a Flash Memory on the motherboard. This program is a bridge between motherboard and operating system. When you start the computer, the BIOS program will gain control. The BIOS first operates an auto-diagnostic test called POST (power on self test) for all the necessary hardware, it detects the entire hardware device and configures the parameters of the hardware synchronization. Only when these tasks are completed done it gives up control of the computer to operating system (OS). Since the BIOS is the only channel for hardware and software to communicate, it is the key factor for system stability, and in ensuring that your system performance as its best.

In the BIOS Setup main menu of Figure 3-1, you can see several options. We will explain these options step by step in the following pages of this chapter, but let us first see a short description of the function keys you may use here:

- Press <Esc> to quit the BIOS Setup.
- Press ↑↓←→ (up, down, left, right) to choose, in the main menu, the option you want to confirm or to modify.
- Press <F10> when you have completed the setup of BIOS parameters to save these parameters and to exit the BIOS Setup menu.

-
-
- Press +/- keys when you want to modify the BIOS parameters for the active option.

3-1 Entering Setup

Power on the computer and by pressing immediately allows you to enter Setup. If the message disappears before your respond and you still wish to enter Setup, restart the system to try again by turning it OFF then ON or pressing the “RESET” button on the system case. You may also restart by simultaneously pressing <Ctrl>, <Alt> and <Delete> keys. If you do not press the keys at the correct time and the system does not boot, an error message will be displayed and you will again be asked to

Press to enter Setup

3-2 Getting Help

Main Menu

The on-line description of the highlighted setup function is displayed at the bottom of the screen.

Status Page Setup Menu/Option Page Setup Menu

Press F1 to pop up a small help window that describes the appropriate keys to use and the possible selections for the highlighted item. To exit the Help Window, press <Esc>.

3-3 The Main Menu

Once you enter AMI ® BIOS CMOS Setup Utility, the Main Menu (Figure 3-1) will appear on the screen. The Main Menu allows you to select from fourteen setup functions and two exit choices. Use arrow keys to select among the items and press <Enter> to accept or enter the sub-menu.



Figure 3-1

Standard BIOS Features

Use this Menu for basic system configurations.

Advanced BIOS Features

Use this menu to set the Advanced Features available on your system.

Advanced Chipset Features

Use this menu to change the values in the chipset registers and optimize your system's performance.

Integrated Peripherals

Use this menu to specify your settings for integrated peripherals.

Power Management Setup

Use this menu to specify your settings for power management.

PnP/PCI Configurations

Use this menu to specify your settings for PnP and PCI configurations.

PC Health Status

This entry shows your PC health status.

Miscellaneous Control

Use this menu to specify your settings for Miscellaneous Control.

Load Optimized Defaults

Use this menu to load the BIOS default values these are setting for optimal performances system operations for performance use.

Load Standard Defaults

Use this menu to load the BIOS default values for the minimal/stable performance system operation

Set Supervisor Password

Use this menu to set supervisor password.

Set User Password

Use this menu to set user password.

Save & Exit Setup

Save CMOS value changes to CMOS and exit setup.

Exit Without Saving

Abandon all CMOS value changes and exit setup.

3-4 Standard BIOS Features

The items in Standard CMOS Setup Menu are divided into several categories. Each category includes no, one or more than one setup items. Use the arrow keys to highlight the item and then use the <PgUp> or <PgDn> keys to select the value you want in each item.



System Date

Use [Enter], [TAB] or [SHIFT+TAB] to select setting filed. Then use [+] or [-] to configure system date.

The date format is <day><month><date><year>.

Day Day of the week is from Sun to Sat, determined by BIOS. Read-only.

Month The month is from Jan. through Dec.

Date The date from 1 to 31 can be keyed by numeric function keys.

Year The year depends on the year of the BIOS.

System Time

Use [Enter], [TAB] or [SHIFT+TAB] to select setting filed. Then use [+] or [-] to configure system time.

The time format is <hour><minute><second>.

SATA 1/SATA 2

While entering setup, BIOS auto detects the presence of hard disk devices. This displays the status of auto detection of hard disk devices.

Type: The optional settings are: [Not Installed]; [Auto]; [CD/DVD] and [ARMD].

LBA/Large Mode: The optional settings are [Auto]; [Disabled].

Disabled: disables LBA mode.

Auto: enables LBA Mode if the devices support it and the device is not already formatted with LBA Mode disabled.

Block (Multi-Sector Transfer): The optional settings are: [Disabled] and [Auto].

Disabled: The Data transfer from and to the device occurs one sector at a time.

Auto: The Data transfer from and to the device occurs multiple sectors at a time if the device supports it.

32 Bit Data Transfer: the optional settings are: [Disabled] and [Enabled].

3-5 Advanced BIOS Features

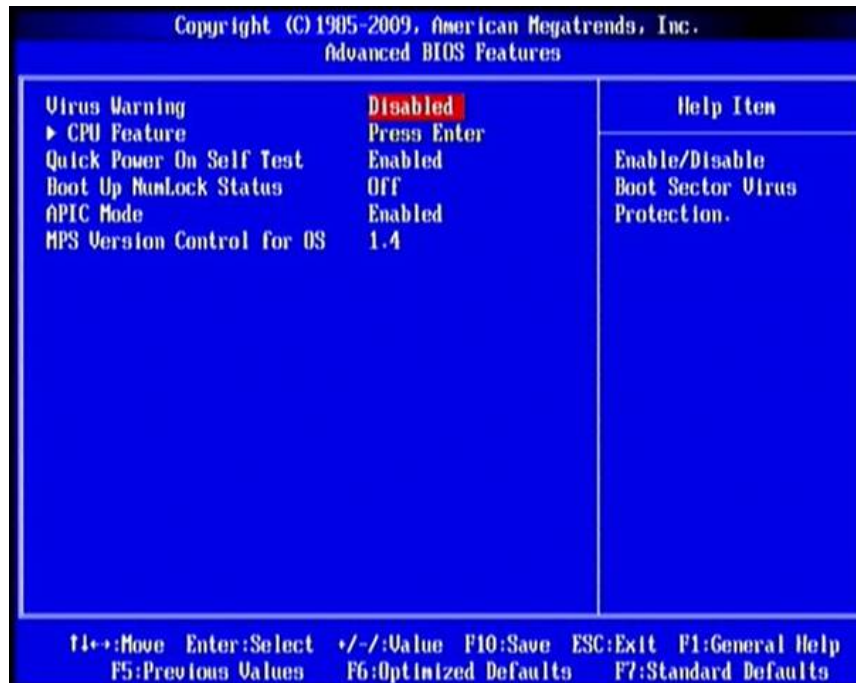

Virus Warning

The selection Allow you to choose the VIRUS Warning feature for Hard Disk boot sector protection. If this function is enabled and someone attempt to write data into this area, BIOS will show a warning message on screen and alarm beep.

Disabled (default) No warning message to appear when anything attempts to access the boot sector or hard disk partition table.

Enabled Activates automatically when the system boots up causing a warning message to appear when anything attempts to access the boot sector of hard disk partition table.

Quick Power On Self Test

This item allows BIOS to skip certain tests while booting. This will decrease the time needed to boot the system. The optional settings: [Disabled]; [Enabled].

Boot Up NumLock Status

Use this item to select power-on state for Numlock key.

APIC Mode

Use this item to include ACPI APIC table pointer to ESDT pointer list. The optional settings are: Disabled; Enabled.

MPS Version Control for OS

This option is only valid for multiprocessor motherboards as it specifies the version of The Multiprocessor Specification (MPS) that the motherboard will use. The optional settings: [1.1]; [1.4].

3-5-1 CPU Feature

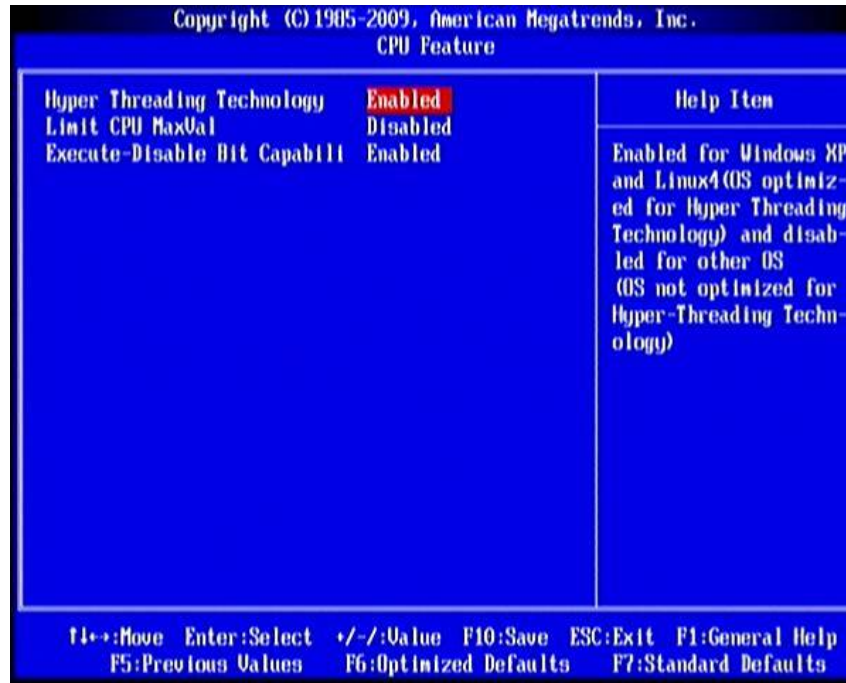

Hyper Threading Technology

Enabled for Windows XP and Linux4(OS optimized for Hyper Threading Technology) and disabled for other OS (OS not optimized for Hyper –Threading Technology).

Limit CPU MaxUal

The optional settings are: [Disabled]; [Enabled].

Execute Disable Bit Capabill

The optional settings are: [Disabled]; [Enabled]. When disabled, force the XD feature Flag to always return 0.

3-6 Advanced Chipset Features

The Advanced Chipset Features Setup option is used to change the values of the chipset registers. These registers control most of the system options in the computer.



DRAM Timing Settings by SPD

The optional settings are: [Disabled]; [Enabled].

Initiate Graphic Adapter

The optional settings are: [IGD]; [PCI/IGD]. Select which graphic controller to use as the primary boot device.

IGD Mode Select

Use this item to select the amount of system memory used by the internal graphics device. The optional settings: [Disabled]; [Enabled, 8MB].

LVDS

The optional settings are: [Enabled]; [Disabled].

When set as [Enabled], the following setting items will appear:

Boot Display Device

The optional settings are: [VBIOS Default]; [CRT]; [LVDS]; [CRT+LVDS].

Flat Panel Type

Use this item to select flat panel resolution type.

The optional settings are: [640X 480]; [800X 600]; [1024X768]; [800X480]; [1024X600]; [1366X768]; [1280X768]; [1280X800];[1280X600]; [1280X1024].

Backlight Control Support

The optional settings are: [VBIOS Default];[Both BLC & BIA Disabled];[BLC Enabled].

3-7 Integrated Peripherals



3-7-1 Onboard SATA Function

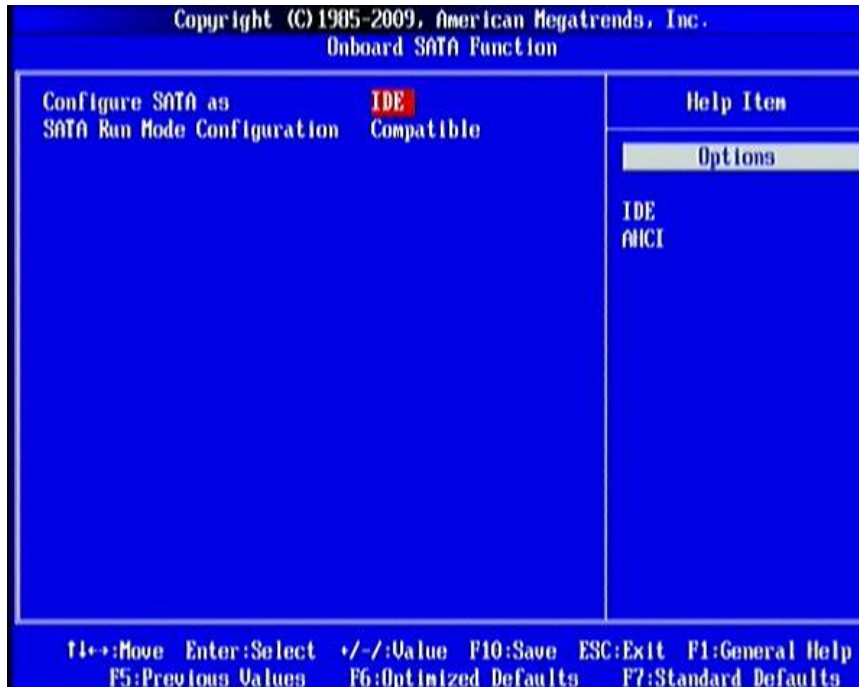

Configure SATA as

The optional settings are: [IDE]; [AHCI].

SATA Run Mode Configuration

The optional settings are: [Compatible];[Enhanced].

3-7-2 Onboard Device Function

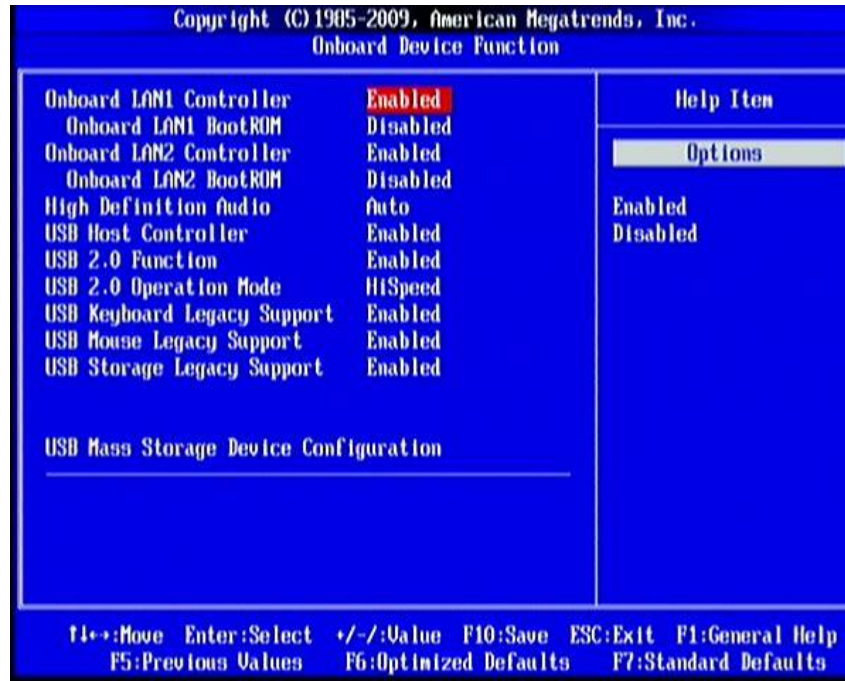

Onboard LAN1/2 Controller

The optional settings are: [Enabled]; [Disabled].

Onboard LAN1/2 BootROM

The optional settings are: [Enabled]; [Disabled].

High Definition Audio

The settings are: [Auto];[Disabled].

USB Host Controller

The optional settings: [Enabled]; [Disabled].

USB 2.0 Function

The optional settings: [Enabled]; [Disabled].

USB 2.0 Operation Mode

Use this item to configure the USB 2.0 controller in HiSpeed(480Mbps) or FullSpeed(12Mbps).

The settings are: [FullSpeed]; [HiSpeed].

BIOS XHCI Hand Off

The optional settings are: Enabled; Disabled.

USB Keyboard Legacy/Mouse Legacy /Storage Legacy Support

Use these items to enable or disable legacy support for USB keyboard/mouse/ mass storage devices. The settings are: [Enabled], [Disabled].

3-7-3 Onboard Super IO Function

Copyright (C) 1985-2009, American Megatrends, Inc.		
Onboard Super IO Function		
		Help Item
Serial Port1 Address	3F0/IRQ4	Allows BIOS to Select Serial Port1 Base Addresses.
Serial Port2 Address	2F0/IRQ3	
Serial Port2 RS485 Select	Disabled(RS232)	
Parallel Port Address	370	
Parallel Port Mode	Normal	
Serial Port3 Address	4E0	
Serial Port3 IRQ	10	
Serial Port4 Address	4E0	
Serial Port4 IRQ	10	
Serial Port5 Address	4F0	
Serial Port5 IRQ	10	
Serial Port6 Address	4F0	
Serial Port6 IRQ	10	
WatchDog Timer Control	Disabled	

F1: Move Enter: Select +/-: Value F10: Save ESC: Exit F1: General Help
F5: Previous Values F6: Optimized Defaults F7: Standard Defaults

Serial Port 1/2 Address

This item allows BIOS to select base addresses for serial port 1/2.

Serial Port 2 RS485 Select

The optional settings are: [Disabled(RS232)]; [Enabled(RS485)].

Parallel Port Address

Use this item to allow BIOS to select parallel port base addresses.

Parallel Port Mode

The optional settings are: [Normal]; [Bi-Directional]; [ECP]; [EPP]; [ECP & EPP].

Serial Port 3/4/5/6 Address

This item allows BIOS to select base addresses for serial port 3/4/5/6.

Serial Port 3/4/5/6 IRQ

This item allows BIOS to select serial port 3/4/5/6 IRQ.

Watchdog Timer Select

This item is used to activate the watchdog function. The optional settings are: [Enabled]; [Disabled].

When set as Enabled, The following sub-items shall appear:

WatchDog Timer Val

User can type a number in the range of 4 to 255.

WatchDog Timer Unit

The optional settings are: [Sec.]; [Min.].

3-8 Power Management Setup

The Power Management Setup allows you to configure your system to most effectively save energy saving while operating in a manner consistent with your own style of computer use.

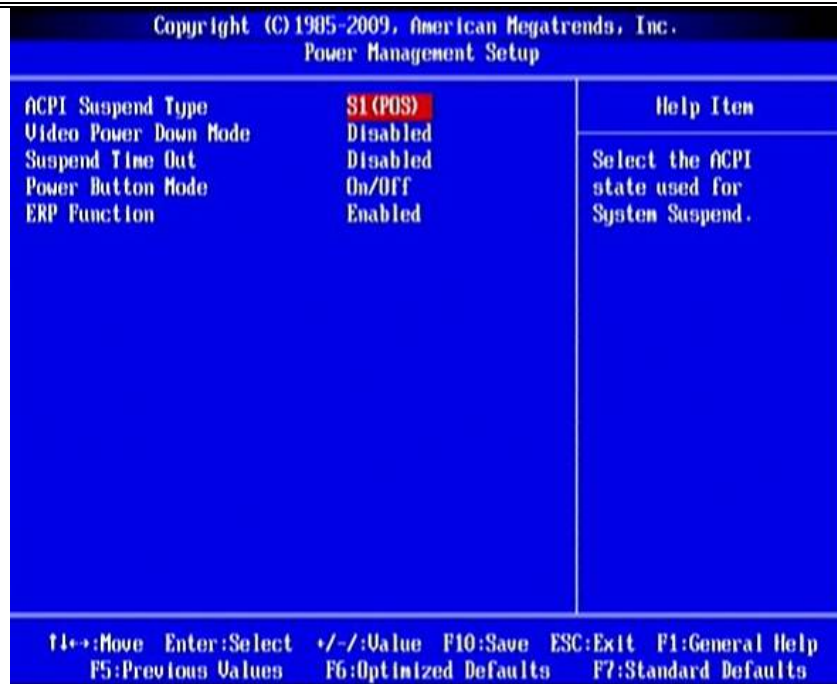

ACPI Suspend Type

Users can select the ACPI state used for system suspend. The optional settings are: [S1(POS)]; [S3(STR)].

Video Power Down Mode

The optional settings: [Disabled]; [Standby]; [Suspend].

Suspend Time out

Use this item to select the specified time for system to go into suspend.

Power Button Mode

Use this item to go into [On/Off] or [Suspend] when power button is pressed.

ERP Function

The optional settings are: [Enabled]; [Disabled]. When set as [Disabled], the following sub-items shall appear:

Wake-Up by PCI Card; Power On by Ring; Wake Up by USB from S3(S4); PS2 KB/MS Wake-Up from S3-S5; Resume On RTC Alarm.

User can set them as Enabled or Disable for to enable or disable respective functions.

3-9 PnP/PCI Configurations

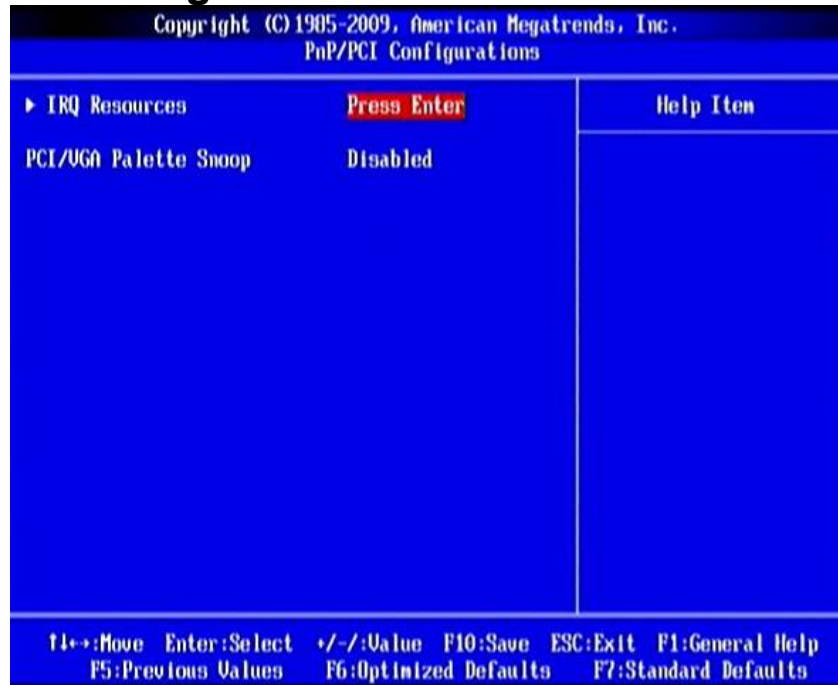

IRQ Resources

Press [Enter] to view IRQ availability.

Available: Specified IRQ is available to be used by PCI/PnP devices.

Reserved: Specified IRQ is reserved for use by legacy ISA devices.

PCI/VGA Palette Snoop

The optional settings are: [Enabled]; [Disabled].

Enabled: to inform the PCI devices that an ISA graphics device is installed in the system so the card will function correctly.

3-10 PC Health Status

This section shows the Status of you CPU, Fan, and Warning for overall system status.

This is only available if there is Hardware Monitor onboard.

Copyright (C) 1985-2009, American Megatrends, Inc.
PC Health Status

		Help Item
Shutdown Temperature	Disabled	
CPU Thermal-Throttling	Disabled	
▶ Smart FAN Configurations	Press Enter	
CPU Temperature	36°C/96°F	
System Temperature	35°C/95°F	
		Disabled
		60°C/140°F
		65°C/149°F
		70°C/158°F
		75°C/167°F
CPUFAN Speed	5263 RPM	
SYSFAN1 Speed	N/A	
SYSFAN2 Speed	N/A	
Vcore	1.144 V	
NB 1.05V	1.040 V	
5VSB	4.972 V	
VDIMM	1.520 V	
+ 5V	5.002 V	
+ 12V	11.792 V	
Vcc3V	3.216 V	
3VSB	3.232 V	
VBat	3.320 V	

F4←→:Move Enter:Select +/=:Value F10:Save ESC:Exit F1:General Help
F5:Previous Values F6:Optimized Defaults F7:Standard Defaults

Shutdown Temperature

This item can let users set the Shutdown temperature, when CPU temperature over this setting the system will auto shutdown to protect CPU.

CPU Thermal Throttling

The optional settings are: [Disabled]; [Enabled].

When it is set as [Enabled], use can make settings for the following items that show up:

CPU Thermal-Throttling Temp.;

Use can select specific temperature for CPU Thermal Throttling function.

CPU Thermal-Throttling Duty

The optional settings are: [87.50%]; [75.00%]; [62.50%]; [50.00%]; [37.50%]; [25.00%]; [12.50%].

CPU Thermal-Throttling Beep.

The optional settings are: [Disabled]; [Enabled].

Smart Fan Configuration

CPUFAN / SYSFAN1/ SYSFAN2 Smart Mode

When set as [Enabled], the following sub-items shall appear:

CPUFAN / SYSFAN1/ SYSFAN2 Full Speed Temp

Use this item to set a degree for CPUFAN/SYSFAN1/SYSFAN2. FAN will run at full speed when above this temperature.

CPUFAN / SYSFAN1/ SYSFAN2 Idle Temp

Use this item to set a degree for CPUFAN/SYSFAN1/SYSFAN2. FAN will idle speed when below this temperature.

CPUFAN / SYSFAN1/ SYSFAN2 Idle Speed Duty

Use this item to set idle speed duty for CPUFAN/SYSFAN1/SYSFAN2.

CPU Temperature/ System Temperature /CPUFAN Speed / SYSFAN1 Speed /SYSFAN2 Speed/ Vcore/ /NB1.05V/5VSB/VDIMM/ +5V/+12V/Vcc3V

This will show the CPU/FAN/System voltage chart and FAN Speed, etc.

3-11 Miscellaneous Control



Spread Spectrum

The optional settings are: [Enabled]; [Disabled].

Linear PCIEX Clock

The optional settings are from 100 to 200.

DRAM Clock at Next Boot

This item allows you to set DRAM clock. The optional settings are: [Auto]; [667MHz]; [800MHz].

Host/PCI Clock at Next Boot

The optional settings are from 200 to 600.

VDIMM Select

The optional settings are: [1.52V (Default)]; [1.55V]; [1.60V]; [1.65V].

3-12 Password Setting

You can set either supervisor or user password, or both of them. The differences are:

Supervisor password: Can enter and change the options of the setup menus.

User password: Can only enter but do not have the right to change the options of the setup menus. When you select this function, the following message will appear at the center of the screen to assist you in creating a password.

ENTER PASSWORD:

Type the password, up to eight characters in length, and press <Enter>. The password typed now will clear any previously entered password from CMOS memory. You will be asked to confirm the password. Type the password again and press <Enter>. You may also press <Esc> to abort the selection and not enter a password. To disable a password, just press <Enter> when you are prompted to enter the password. A message will confirm that the password will be disabled. Once the password is disabled, the system will boot and you can enter Setup freely.

PASSWORD DISABLED.

When a password has been enabled, you will be prompted to enter it every time you try to enter Setup. This prevents an unauthorized person from changing any part of your system configuration.

Additionally, when a password is enabled, you can also require the BIOS to request a password every time your system is rebooted. This would prevent unauthorized use

of your computer.

You determine when the password is required within the BIOS Features Setup Menu and its Security option. If the Security option is set to “System”, the password will be required both at boot and at entry to Setup. If set to “Setup”, prompting only occurs when trying to enter Setup.

3-13 Load Optimized /Standard Defaults

Load Optimized Defaults

When you press <Enter> on this item, you get a confirmation dialog box with a message similar to:



Pressing <OK> loads the default values that are factory settings for optimal performance system operations.

Load Standard Defaults

When you press <Enter> on this item, you get a confirmation dialog box with a message similar to:



Pressing <OK> loads the default values that are factory settings for stable performance system operations.

3-14 Save & Exit Setup/ Exit Without Saving

Save and Exit Setup

When you press <Enter> on this item, you get a confirmation dialog box with a message similar to:

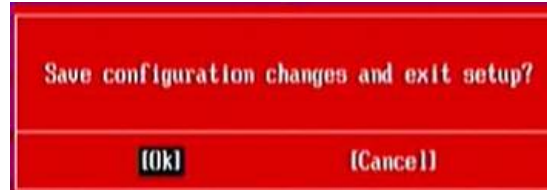

Pressing <OK> save the values you made previously and exit BIOS setup.

Exit Without Saving

When you press <Enter> on this item, you get a confirmation dialog box with a message similar to:



Pressing <OK> to leave BIOS setting without saving previously set values.