

TECHNICAL MANUAL
Of
Intel GM45 Express Chipset
&
ICH9M Series Chipset
Based
Mini-ITX M/B for Penryn Processor

NO.G03-NF93-F

Revision : 5.0

Released in: September, 2011

Trademark:

* Specifications and Information contained in this documentation are furnished for information use only, and are subject to change at any time without notice, and should not be construed as a commitment by manufacturer.

Environmental Protection Announcement

Do not dispose this electronic device into the trash while discarding. To minimize pollution and ensure environment protection of mother earth, please recycle.



TABLE OF CONTENT

ENVIRONMENTAL SAFETY INSTRUCTION	iv
USER'S NOTICE	v
MANUAL REVISION INFORMATION	v
ITEM CHECKLIST	v
CHAPTER 1 INTRODUCTION OF THE MOTHERBOARD	
1-1 FEATURE OF MOTHERBOARD	1
1-2 SPECIFICATION.....	2
1-3 LAYOUT DIAGRAM	3
CHAPTER 2 HARDWARE INSTALLATION	
2-1 JUMPER SETTING	8
2-2 CONNECTORS AND HEADERS	11
2-2-1 CONNECTORS.....	11
2-2-2 HEADERS	12
CHAPTER 3 INTRODUCING BIOS	
3-1 ENTERNING SETUP	21
3-2 GETTING HELP	21
3-3 THE MAIN MENU.....	21
3-4 ADVANCED BIOS FEATURES.....	24
3-4-1 CPU FEATURES	27
3-5 INTEGRATED PHERIPHRALS.....	27
3-5-1 INTEL DTS FEATURE	28
3-6 PC HEALTH STATUS.....	30
3-7 ADVANCED CHIPSET FEATURES	31
3-8 POWER MANAGEMENT SETUP	32
3-9 PNP/PCI CONFIGURATIONS.....	34



Environmental Safety Instruction

- Avoid the dusty, humidity and temperature extremes. Do not place the product in any area where it may become wet.
- 0 to 60 centigrade is the suitable temperature. (The figure comes from the request of the main chipset)
- Generally speaking, dramatic changes in temperature may lead to contact malfunction and crackles due to constant thermal expansion and contraction from the welding spots' that connect components and PCB. Computer should go through an adaptive phase before it boots when it is moved from a cold environment to a warmer one to avoid condensation phenomenon. These water drops attached on PCB or the surface of the components can bring about phenomena as minor as computer instability resulted from corrosion and oxidation from components and PCB or as major as short circuit that can burn the components. Suggest starting the computer until the temperature goes up.
- The increasing temperature of the capacitor may decrease the life of computer. Using the close case may decrease the life of other device because the higher temperature in the inner of the case.
- Attention to the heat sink when you over-clocking. The higher temperature may decrease the life of the device and burned the capacitor.

USER'S NOTICE

COPYRIGHT OF THIS MANUAL BELONGS TO THE MANUFACTURER. NO PART OF THIS MANUAL, INCLUDING THE PRODUCTS AND SOFTWARE DESCRIBED IN IT MAY BE REPRODUCED, TRANSMITTED OR TRANSLATED INTO ANY LANGUAGE IN ANY FORM OR BY ANY MEANS WITHOUT WRITTEN PERMISSION OF THE MANUFACTURER.

THIS MANUAL CONTAINS ALL INFORMATION REQUIRED TO USE THIS MOTHER-BOARD SERIES AND WE DO ASSURE THIS MANUAL MEETS USER'S REQUIREMENT BUT WILL CHANGE, CORRECT ANY TIME WITHOUT NOTICE. MANUFACTURER PROVIDES THIS MANUAL "AS IS" WITHOUT WARRANTY OF ANY KIND, AND WILL NOT BE LIABLE FOR ANY INDIRECT, SPECIAL, INCIDENTAL OR CONSEQUENTIAL DAMAGES (INCLUDING DAMAGES FOR LOSS OF PROFIT, LOSS OF BUSINESS, LOSS OF USE OF DATA, INTERRUPTION OF BUSINESS AND THE LIKE).

PRODUCTS AND CORPORATE NAMES APPEARING IN THIS MANUAL MAY OR MAY NOT BE REGISTERED TRADEMARKS OR COPYRIGHTS OF THEIR RESPECTIVE COMPANIES, AND THEY ARE USED ONLY FOR IDENTIFICATION OR EXPLANATION AND TO THE OWNER'S BENEFIT, WITHOUT INTENT TO INFRINGE.

Manual Revision Information

Reversion	Revision History	Date
5.0	Fifth Edition	September, 2011

Item Checklist

- Motherboard
- Cable(s)
- CD for motherboard utilities
- Motherboard User's Manual
- Back panel

Chapter 1

Introduction of the Motherboard

1-1 Feature of Motherboard

- Intel GM45+ICH9M Series chipset.
- Penryn CPU, with low power consumption never denies high performance.
- Support FSB 1066MHz.
- Support two DDRII SODIMM 800/667MHz up to 4 GB.
- Onboard dual REALTEK RTL 8111C Gigabit Ethernet LAN chip.
- Integrated ALC888 6-channel HD audio CODEC.
- Support USB2.0 data transport demands.
- Support RS422/485 and watchdog.
- Support GPIO function.
- Support Raid 0, Raid 1 function (only for NF93R).

1-2 Specification

Spec	Description
Design	* Mini ITX form factor 8 layers PCB size: 17.0x17.0cm
Chipset	* Intel GM45+ICH9M series chipset
CPU	* Penryn CPU
Memory Socket	* 200-pin DDRII SO-DIMM slot x2 * Support DDRII SODIMM 800/667 MHz system Modules DDRII SODIMM memory * Expandable to 4GB.
Expansion Slots	* 32-bit PCI slot x 1pcs * Mini PCI-E slot x 1pcs
Integrate IDE	* One PCI IDE controller that supports PCI Bus Mastering, ATA PIO/DMA and the ULTRA DMA 100/66 functions that deliver the data transfer rate up to 100 MB/s. * Support Raid 0, Raid 1 function(only for NF93R)
LAN	* Integrated dual Realtek RTL8111C PCI-E Gigabit LAN chip * Support Fast Ethernet LAN function of providing 10Mb/100Mb/1000Mb Ethernet data transfer rate
Audio	* ALC888 6-channel audio codec integrated * Audio driver and utility included
BIOS	* Award 8MB Flash DIP ROM
Multi I/O	* HDMI connector x1 * DVI-D connector x1 * VGA connector x1 * RJ-45 LAN connector x2 * USB 2.0 port x 4 * COM connector x 2

	<ul style="list-style-type: none"> * Audio connector x1 (Line-in, Line-out, MIC,SPDIF_OUT) * SATAII x4 * LVDS header x1 * Invert header x1 * TV OUT header x1 * RS422/RS485 header x1 * Front panel header x1 * CPUFAN x1 /SYSFAN x2 * COM port header x2 * USB 2.0 headers x 3 (expandable to 6 x USB 2.0 ports) * GPIO header * PS2 KBMS header x1 * IDE hard disk drive header x1
--	--

1-3 Layout Diagram

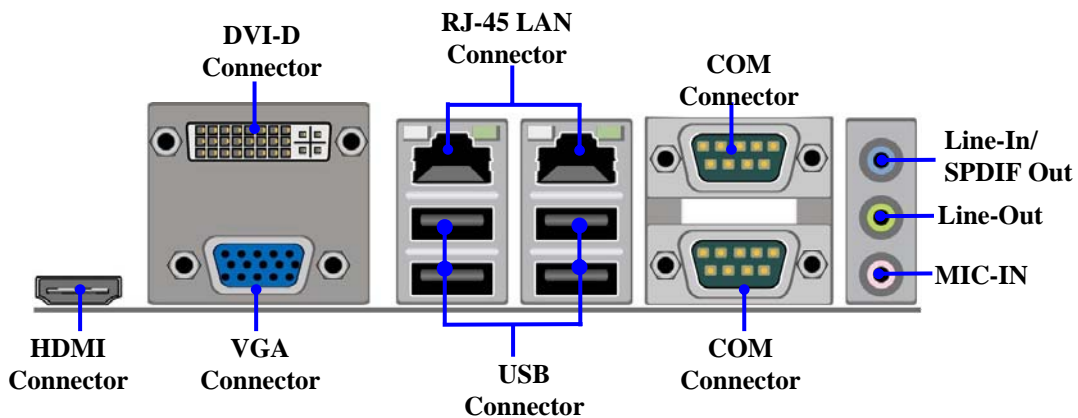

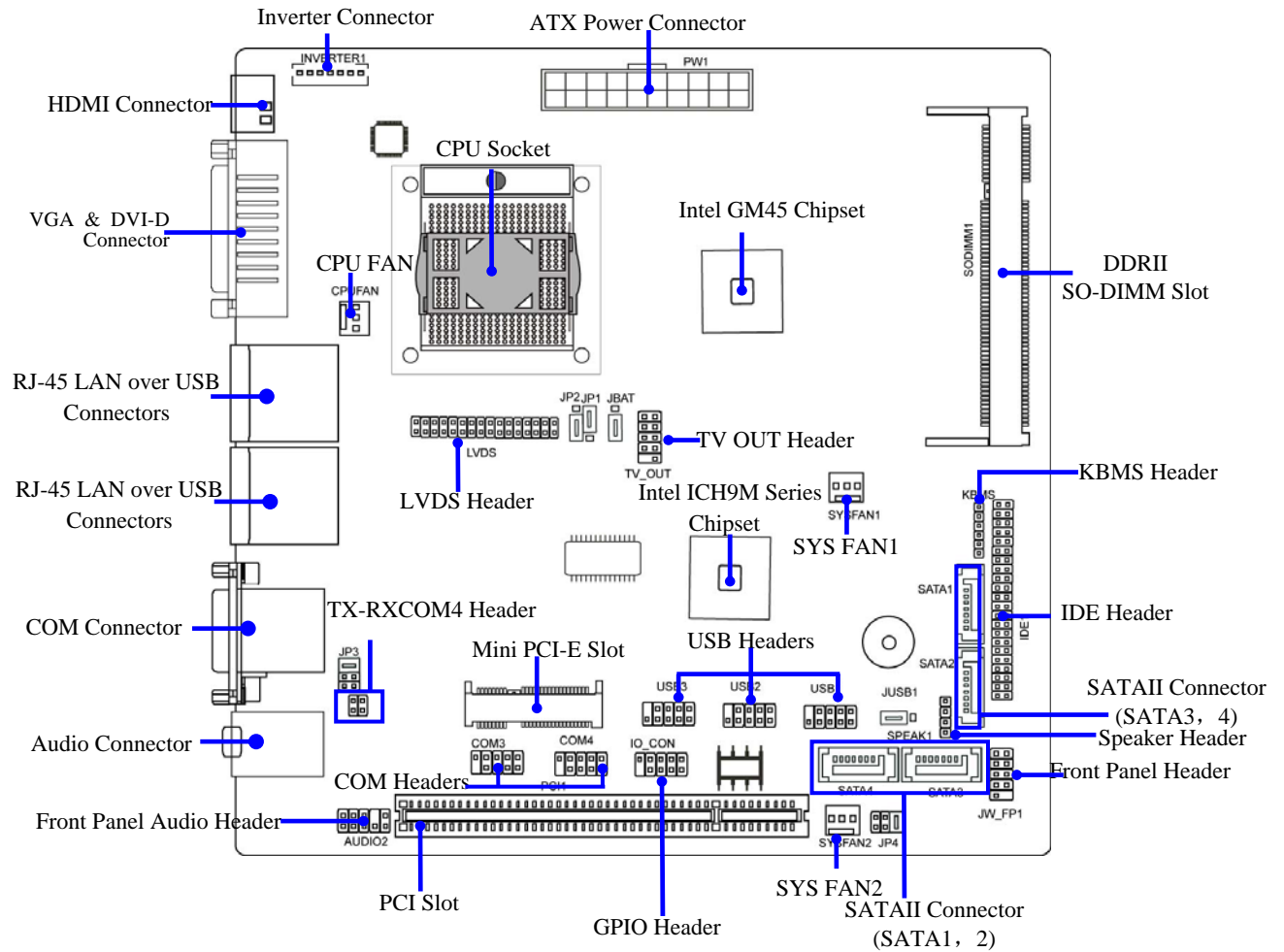

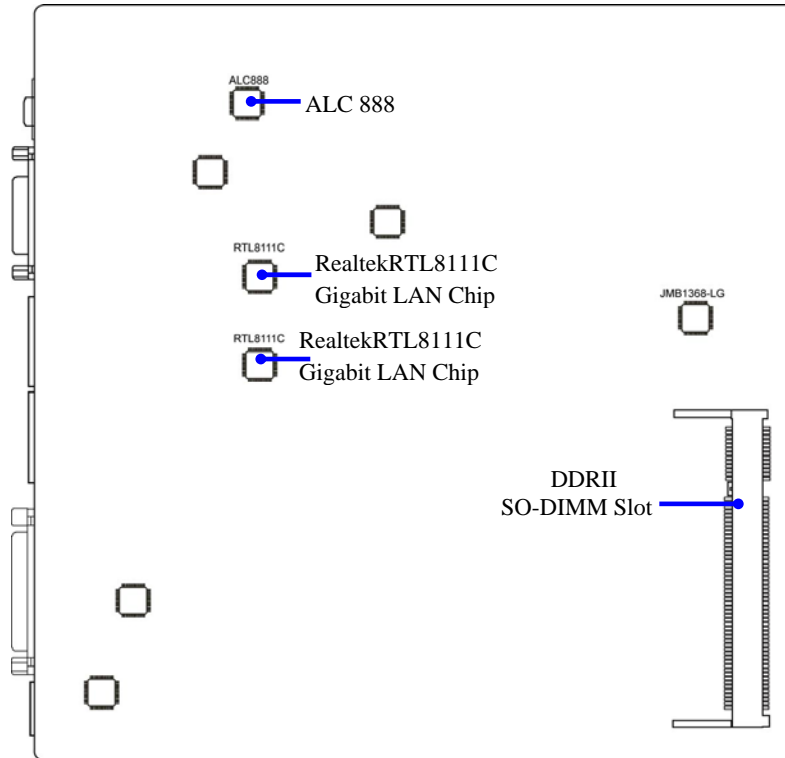

Jumper

Jumper	Name	Description	Page
JBAT	CMOS RAM Clear Function Setting	3-pin Block	P.8
JP1	Panel Backlight Select	3-pin Block	P.8
JP2	Panel VDD Select	3-pin Block	P.9
JP3	COM4 RS232/422/485 Function Select	6-pin Block	P.9
JP4	COM4 RS232 Power Select	6-pin Block	P.10
JUSB1	USB1/2/3 Power Select	3-pin Block	P.10

Connectors

Connector	Name	Description	Page
HDMI	HDMI port connector	19-pin Connector	P.11
VGA-DVI(Bellow)	Video Graphic Attach Connector	15-pin Connector	P.11
VGA-DVI(Above)	DVI-D Port Connector	24-pin Connector	P.11
UL1/ UL2 (Middle/Bellow)	USB Port Connector x4	4-pin Connector	P.11
UL1/ UL2 (Above)	RJ-45 LAN Connector x2	8-pin Connector	P.11
COM1	Serial Port Connectors x2	9-pin Connector	P.11
AUDIO1	Line-Out /MIC/Line-In Audio Connector	3- Phone Jack	P.11
SATA1~4	Serial ATAII Connector	7-pin Connector	P.11

Headers

Header	Name	Description	Page
AUDIO2	Front Panel Audio Header	9-pin Block	P.12
LVDS	LVDS Header	32-pin Block	P.12
INVERTER1	LVDS Inverter Header	7-pin Block	P.14
TV OUT	TV Out Header	9-pin Block	P.14
TX-RX COM4	RS 422/485 Header	4-pin Block	P.15
JW_FP1 (PWR LED/ HD LED/ /Power Button /Reset)	Front Panel Header (PWR LED/ HD LED/ /Power Button /Reset)	9-pin Block	P.15
CPUFAN,SYSFAN1/2	FAN Speed Headers	3-pin Block	P.16
COM3,4	Serial Port COM3/4 Header	9-pin Block	P.16
USB1/2/3	USB 2.0 headers	9-pin Block	P.17
IO_CON	GPIO Header	9-pin Block	P.17
KBMS	PS/2 Keyboard and mouse Header	6-pin Block	P.18
IDE1	IDE Header	44-pin Block	P.18

Chapter 2

Hardware Installation

2-1 Jumper Setting

(1) JBAT (3-pin): Clear CMOS

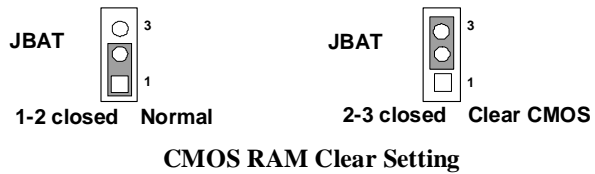
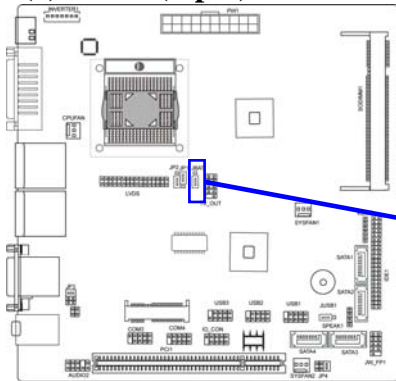

(2) JP1 (3-pin): Panel Backlights Select

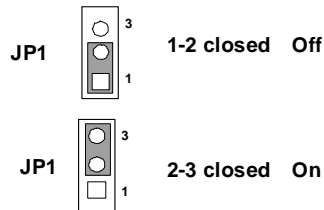
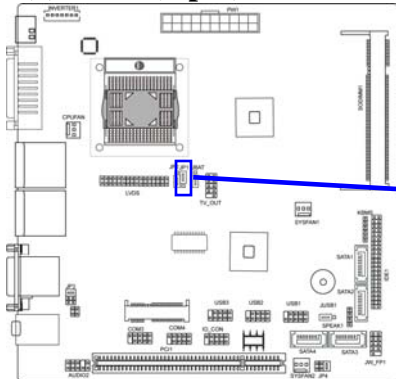

(3) JP2 (3-pin): Panel VDD Select

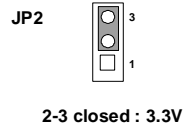
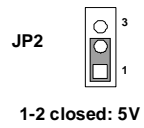
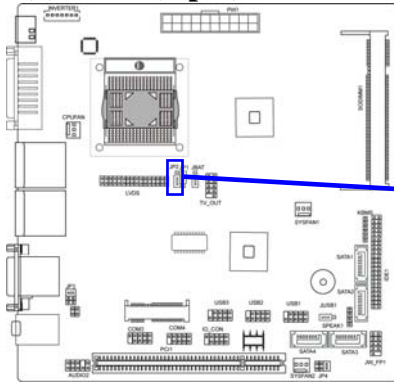

(4) JP3 (6-pin): COM4 RS232/422/485 Function Select

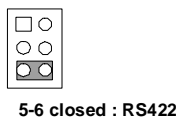
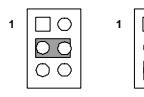
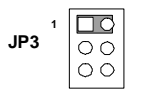
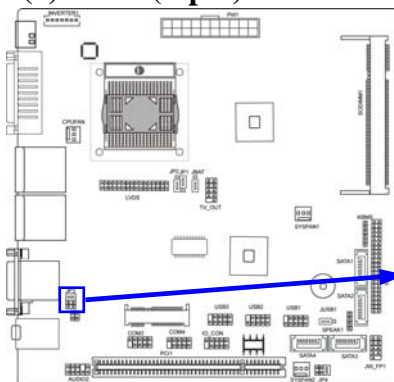

(5) JP4 (6-pin): COM4 RS232 Power Select

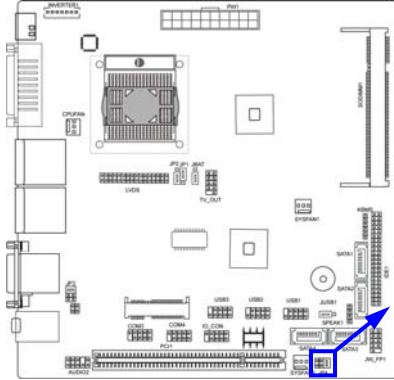

JP4

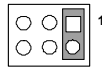

1-2 closed: RS232

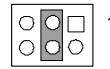

3-4 closed : +12V

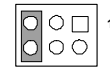

5-6 closed : +5V

(6) JUSB1 (3-pin): USB 1/2/3 Power Select

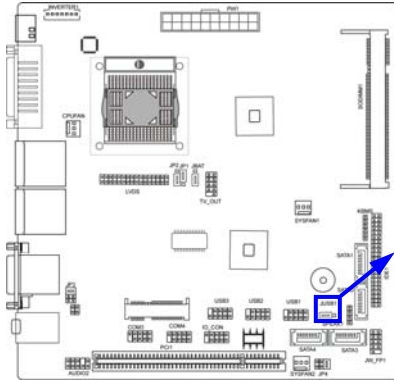

JUSB1



1-2 closed: +5V (Normal)



2-3 closed: + 5VSB

USB1/2/3 Power Select Setting

2-2 Connectors and Headers

2-2-1 Connectors

(1) Audio Connector: (Line-IN/ Line-Out/ MIC-In)

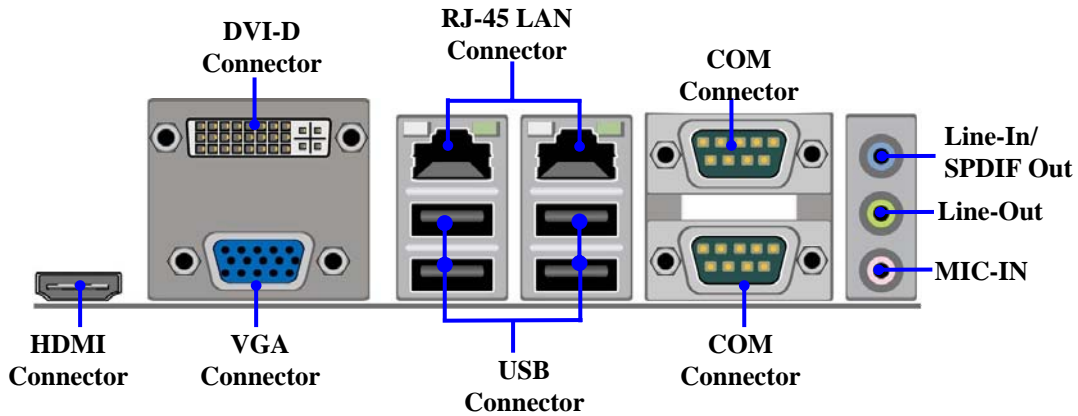

(2) SATA Port connector: SATA1/SATA2/ SATA3/SATA4

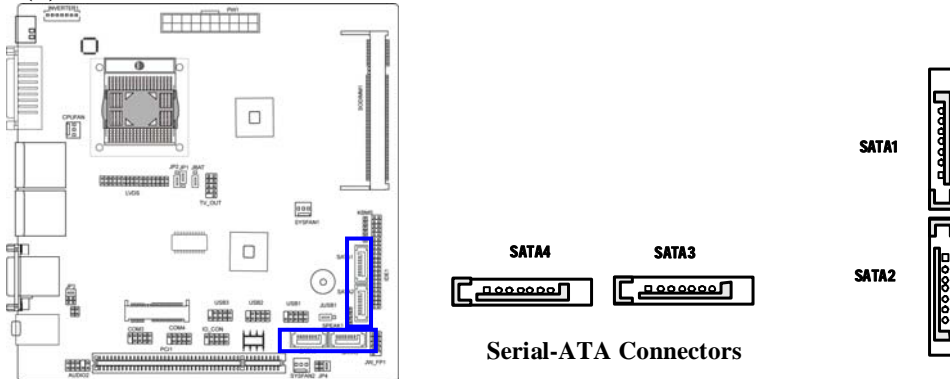

2-2-2 Headers

(1) Front Panel Audio (9-pin): AUDIO2

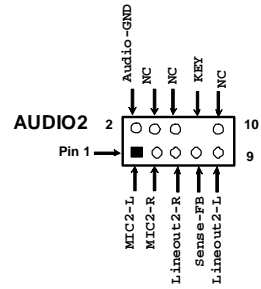
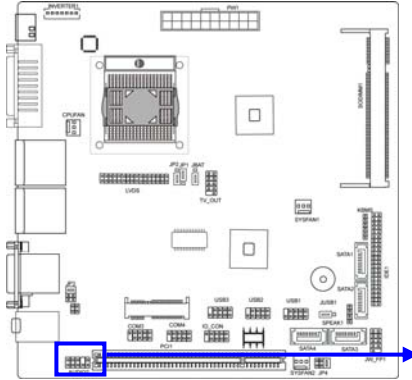

Line-Out, MIC Headers

(2) LVDS Header (32-pin): LVDS

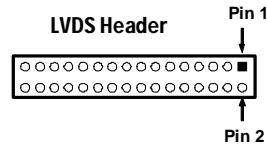
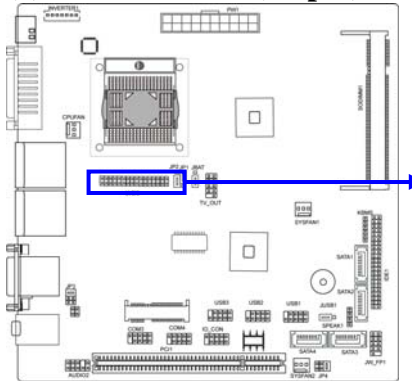

Pin	Pin Definition	Pin	Pin Definition
Pin 1	LVDSB_DATA3-	Pin 2	LVDSB_DATA3+
Pin 3	LVDSB_CLK-	Pin 4	LVDSB_CLK+
Pin 5	LVDSB_DATA2-	Pin 6	LVDSB_DATA2+
Pin 7	LVDSB_DATA1-	Pin 8	LVDSB_DATA1+
Pin 9	LVDSB_DATA0-	Pin 10	LVDSB_DATA0+
Pin 11	DDC DATA	Pin 12	DDC CLOCK
Pin 13	Ground	Pin 14	Ground
Pin 15	Ground	Pin 16	Ground
Pin 17	LVDSA_DATA3+	Pin 18	LVDSA_DATA3-
Pin 19	LVDSA_CLK+	Pin 20	LVDSA_CLK-
Pin 21	LVDSA_DATA2+	Pin 22	LVDSA_DATA2-
Pin 23	LVDSA_DATA1+	Pin 24	LVDSA_DATA1-
Pin 25	LVDSA_DATA0+	Pin 26	LVDSA_DATA0-
Pin 27	PVDD	Pin 28	PVDD
Pin 29	PVDD	Pin 30	PVDD
Pin 31	Ground	Pin 32	Ground

(3) Pin-headers of LVDS Inverter(7-pin): INVERTER1

Pin 1 and pin2: VCC of inverter

Pin3、pin4 and pin6: GND

Pin5: Backlight

Pin7: Brightness

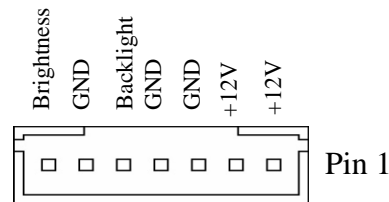
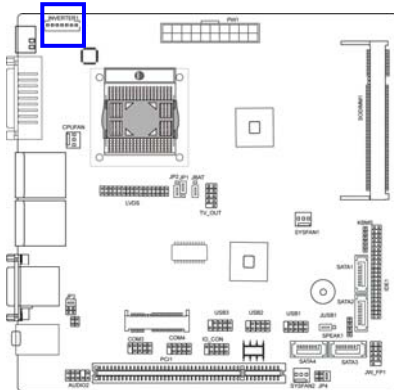

(4)TV-OUT Header (9-pin): TV_OUT

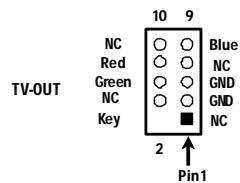
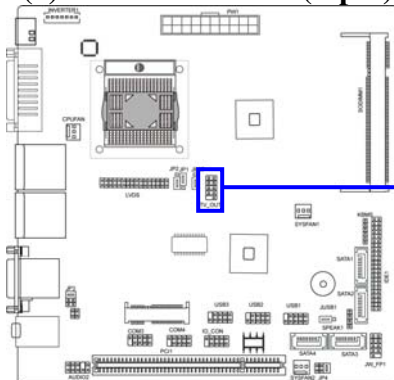

TV-OUT Header

(5) RS422/485 Header (4-pin): TX-RXCOM4

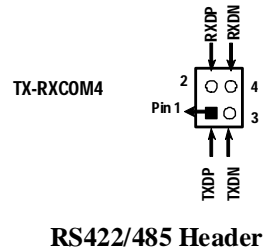
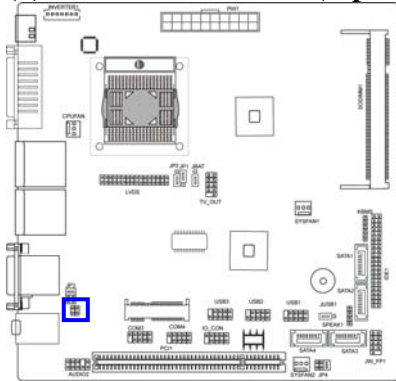

(6) Front Panel Header(9-pin): JW_FP1

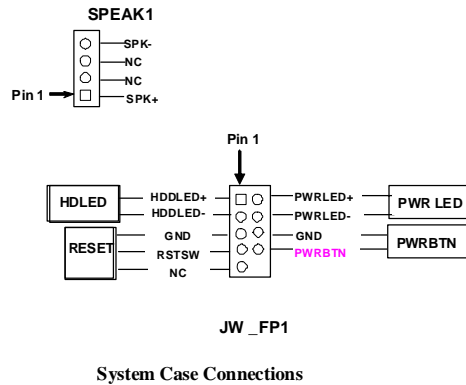
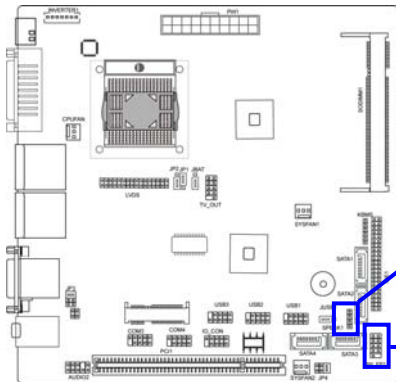

(7) FAN Speed Headers (3-pin): CPUFAN, SYSFAN1/SYSFAN2

Pin1: GND

Pin2: +12V fan power

Pin3: Fan Speed

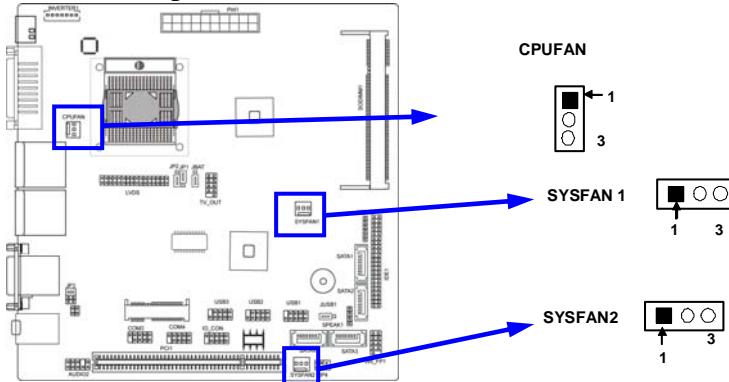

(8) COM Header (9-pin): COM3/COM4

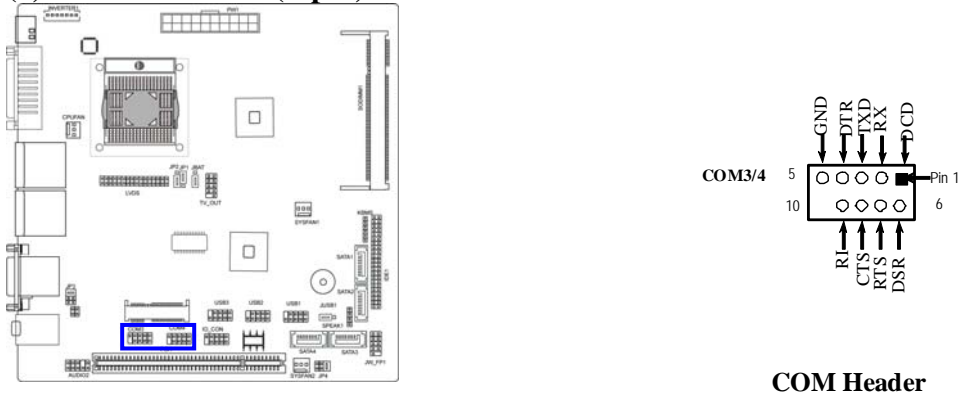

COM Header

(9) USB 2.0 Port Headers (9-pin): USB1/USB2/ USB3

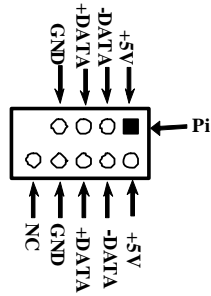
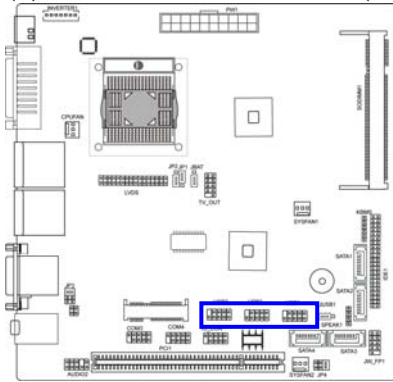

USB 1/2/3 Header

(9) GPIO Header (9-pin): IO_CON

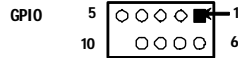
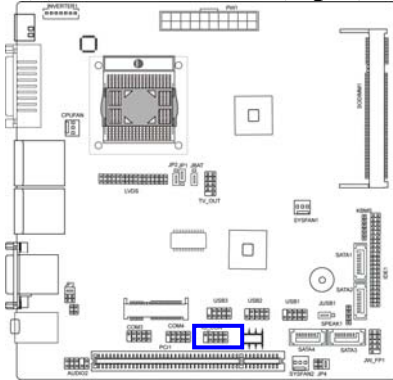

GPIO Header

PIN	Define	PIN	Define
1	GPIO_17	6	GPIO_6
2	GPIO_18	7	GPIO_7
3	GPIO_20	8	GPIO_8
4	GPIO_22	9	GPIO_27
5	GND	10	KEY

(10) KBMS Header (6-pin): KBMS

The header is for PS/2 keyboard and PS/2 Mouse input devices.

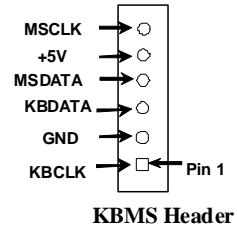
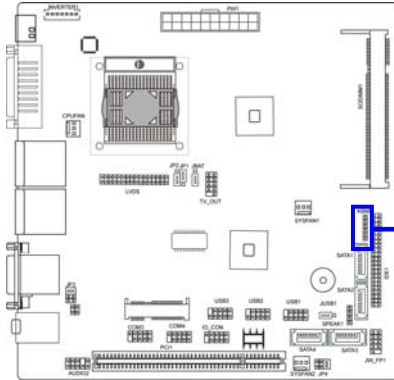

(11) IDE Header (44-pin): IDE1

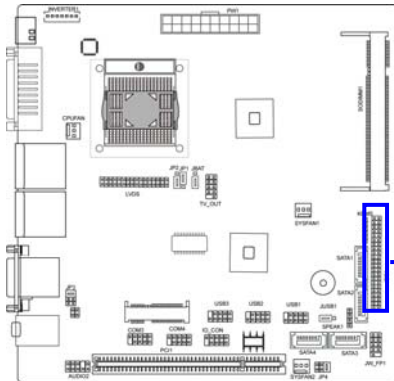

IDE1 Header

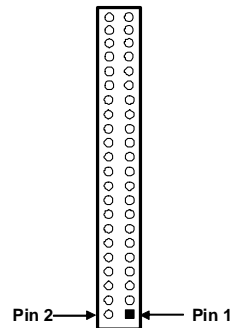

Pin	Definition	Pin	Definition
Pin 1	Reset	Pin 2	GND
Pin 3	DD7	Pin 4	DD8
Pin 5	DD6	Pin 6	DD9
Pin 7	DD5	Pin 8	DD10
Pin 9	DD4	Pin 10	DD11
Pin 11	DD3	Pin 12	DD12
Pin 13	DD2	Pin 14	DD13
Pin 15	DD1	Pin 16	DD14
Pin 17	DD0	Pin 18	DD15
Pin 19	GND	Pin 20	NC
Pin 21	DMARQ	Pin 22	GND
Pin 23	IOW	Pin 24	GND
Pin 25	IOR	Pin 26	GND
Pin 27	IORDY	Pin 28	CSELA
Pin 29	DMACK	Pin 30	GND
Pin 31	JINTRQ	Pin 32	NC
Pin 33	DA1	Pin 34	PDIAG
Pin 35	DA0	Pin 36	DA2
Pin 37	CS	Pin 38	CS1
Pin 39	PRI_ACT	Pin 40	GND
Pin 41	+5V	Pin 42	+5V
Pin 43	GND	Pin 44	NC

Chapter 3

Introducing BIOS

Attention: The BIOS options shown in this manual is for reference use only. We reserve the right to update the BIOS version without advance notice.

The BIOS is a program located on a Flash Memory on the motherboard. This program is a bridge between motherboard and operating system. When you start the computer, the BIOS program will gain control. The BIOS first operates an auto-diagnostic test called POST (power on self test) for all the necessary hardware, it detects the entire hardware device and configures the parameters of the hardware synchronization. Only when these tasks are completed done it gives up control of the computer to operating system (OS). Since the BIOS is the only channel for hardware and software to communicate, it is the key factor for system stability, and in ensuring that your system performance as its best.

In the BIOS Setup main menu of Figure 3-1, you can see several options. We will explain these options step by step in the following pages of this chapter, but let us first see a short description of the function keys you may use here:

- Press <Esc> to quit the BIOS Setup.
- Press ↑↓←→ (up, down, left, right) to choose, in the main menu, the option you want to confirm or to modify.
- Press <F10> when you have completed the setup of BIOS parameters to save these parameters and to exit the BIOS Setup menu.
- Press Page Up/Page Down or +/- keys when you want to modify the BIOS parameters for the active option.

3-1 Entering Setup

Power on the computer and by pressing immediately allows you to enter Setup.

If the message disappears before you respond and you still wish to enter Setup, restart the system to try again by turning it OFF then ON or pressing the “RESET” button on the system case. You may also restart by simultaneously pressing <Ctrl>, <Alt> and <Delete> keys. If you do not press the keys at the correct time and the system does not boot, an error message will be displayed and you will again be asked to

Press <F1> to continue, or to enter Setup

3-2 Getting Help

Main Menu

The on-line description of the highlighted setup function is displayed at the bottom of the screen.

Status Page Setup Menu/Option Page Setup Menu

Press F1 to pop up a small help window that describes the appropriate keys to use and the possible selections for the highlighted item. To exit the Help Window, press <Esc>.

3-3 The Main Menu

Once you enter Award® BIOS CMOS Setup Utility, the Main Menu (Figure 3-1) will appear on the screen. The Main Menu allows you to select from fourteen setup functions and two exit choices. Use arrow keys to select among the items and press <Enter> to accept or enter the sub-menu.

Phoenix - AwardBIOS CMOS Setup Utility

Standard CMOS Features	Load Fail-safe Defaults
Advanced BIOS Features	Load Optimized Defaults
Advanced Chipset Features	Set Supervisor Password
Integrated Peripherals	Set User Password
Power Management Setup	Save & Exit Setup
PnP/PCI Configurations	Exit Without Saving
PC Health Status	
Esc : Quit F9 : Menu in BIOS ↑↓→← : Select Item	
F10 : Save & Exit Setup	

Figure 3-1

Standard CMOS Features

Use this Menu for basic system configurations.

Advanced BIOS Features

Use this menu to set the Advanced Features available on your system.

Advanced Chipset Features

Use this menu to change the values in the chipset registers and optimize your system's performance.

Integrated Peripherals

Use this menu to specify your settings for integrated peripherals.

Power Management Setup

Use this menu to specify your settings for power management.

Miscellaneous Control

Use this menu to specify your settings for **Miscellaneous Control**.

PC Health Status

This entry shows your PC health status.

Power User Overclock Settings

Use this menu to specify your settings (frequency, Voltage) for overclocking demand

CPU Thermal Throttling Setting

The selection is set for activating the active CPU Thermal Protection by flexible CPU loading adjustment in the arrangement of temperature you defined.

Load Optimized Defaults

Use this menu to load the BIOS default values these are setting for optimal performances system operations for performance use.

Password Settings

This entry for setting Supervisor password and User password

Save & Exit Setup

Save CMOS value changes to CMOS and exit setup.

Exit Without Saving

Abandon all CMOS value changes and exit setup.

3-4 Advanced BIOS Features

Phoenix - AwardBIOS CMOS Setup Utility

Advanced BIOS Features

CPU Feature	Press Enter	Item Help	
Hard Disk Boot Priority	Press Enter		
Virus Warning	Disabled	Menu Level >	
CPU L3 Cache	Enabled		
Quick power on self Test	Enabled		
First Boot Device	HARD DISK		
Second Boot Device	CDROM		
Third Boot Device	Disabled		
Boot other Device	Enabled		
Boot Up NumLock Status	On		
Typematic Rate Setting	Disabled		
Typematic Rate (Chars/Sec)	6		
Typematic Delay (Msec)	250		
Security Option	Setup		
APIC Mode	Enabled		
MPS Version Control For OS	1.4		
OS Select For DRAM > 64MB	Non-OS2		
Report No FDD For WIN 95	Yes		
Small Logo(EPA) Show	Disabled		
Summary Screen Show	Disabled		
↑↓→← Move Enter:Select +/-/PU/PD:Value F10:Save ESC:Exit F1:General Help F5:Previous Values F6:Optimized Defaults F7:Standard Defaults			

Hard Disk Boot Priority

The selection is for you to choose the hard disk drives priorities to boot from.

Virus Warning

The selection Allow you to choose the VIRUS Warning feature for IDE Hard Disk boot sector protection. If this function is enabled and someone attempt to write data into this area, BIOS will show a warning message on screen and alarm beep.

Disabled (default) No warning message to appear when anything attempts to access the boot sector or hard disk partition table.

Enabled Activates automatically when the system boots up causing a warning message to appear when anything attempts to access the boot sector of hard disk partition table.

CPU Internal Cache

The default value is Enabled.

Enabled (default) Enable cache

Disabled Disable cache

Note: The internal cache is built in the processor.

External Cache

Choose Enabled or Disabled. This option enables the Level 2 cache memory.

Quick Power On Self-Test

This category speeds up Power On Self Test (POST) after you power on the computer. If this is set to Enabled, BIOS will shorten or skip some check items during POST.

Enabled (default) Enable quick POST

Disabled Normal POST

First/Second/Third Boot Device

The BIOS attempts to load the operating system from the devices in the sequence selected in these items. The settings are Floppy, LS/ZIP, HDD-0/HDD-1/HDD-3, SCSI, CDROM, LAD and Disabled.

Boot Up Floppy Seek

During POST, BIOS will determine if the floppy disk drive installed is 40 or 80 tracks. 360K type is 40 tracks while 760K; 1.2M and 1.44M are all 80 tracks.

Boot Up NumLock Status

The default value is on.

On (default) Keypad is numeric keys.

Off Keypad is arrow keys.

Typematic Rate Setting

Keystrokes repeat at a rate determined by the keyboard controller. When enabled, the typematic rate and typematic delay can be selected. The settings are: Enabled/Disabled.

Typematic Rate (Chars/Sec)

Set the number of times a second to repeat a keystroke when you hold the key down. The settings are: 6, 8, 10, 12, 15, 20, 24, and 30.

Typematic Delay (Msec)

Sets the delay time after the key is held down before beginning to repeat the keystroke. The settings are 250, 500, 750, and 1000.

Security Option

This category allows you to limit access to the system and Setup, or just to Setup.

- | | |
|------------------------|---|
| System | The system will not boot and access to Setup will be denied if the correct password is not entered at the prompt. |
| Setup (default) | The system will boot, but access to Setup will be denied if the correct password is not entered prompt. |

HDD S.M.A.R.T Capability

This option allow you to enable the HDD S.M.A.R.T Capability (Self-Monitoring, Analysis and Reporting Technology) . You can choose from Enabled and Disabled.

MPS Version Control For OS 1.4

This option is only valid for multiprocessor motherboards as it specifies the version of the Multiprocessor Specification (MPS) that the motherboard will use.

OS Select For DRAM > 64MB

Allows OS2[®] to be used with >64MB or DRAM. Settings are Non-OS/2 (default) and OS2. Set to OS/2 if using more than 64MB and running OS/2[®].

3-4-1 CPU Features

Phoenix - AwardBIOS CMOS Setup Utility

CPU Features

C1E Function	Auto	Item Help
CPU C State Capability	Disabled	Menu Level >
Execute Disable Bit	Enabled	
Core Multi-Processing	Enabled	
↑↓→← Move Enter:Select +/-/PU/PD:Value F10:Save ESC:Exit F1:General Help F5:Previous Values F6:Optimized Defaults F7:Standard Defaults		

3-5 Integrated peripherals

Phoenix - AwardBIOS CMOS Setup Utility

Intergrated peripheral

SIO Device	Press Enter	Item Help
Onchip IDE Device	Press Enter	Menu Level >>
Onboard Device	Press Enter	
Intel Dis Feature	Press Enter	
USB Device Setting	Press Enter	
RS422/485 Auto Flow Cntrl	Disabled	
Power On By Mouse	Disabled	
Power On By Keyboard	Disabled	
Watch Dog set	Disabled	
Watch Dog Timer	10	
PWRON After PWR-Fail	Off	
↑↓→← Move Enter:Select +/-/PU/PD:Value F10:Save ESC:Exit F1:General Help F5:Previous Values F6:Optimized Defaults F7:Standard Defaults		

3-5-1 Intel DTS Feature

Phoenix - AwardBIOS CMOS Setup Utility

Intel DTS Feature

Intel DTS Function	Enabled	Item Help
DTS Active temperature	55°C	Menu Level >
Passive Cooling Trip Point	95°C	
Passive TC1 Value	2	
Passive TC2 Value	0	
Passive TSP Value	10	
↑↓→← Move Enter:Select +/-/PU/PD:Value F10:Save ESC:Exit F1:General Help F5:Previous Values F6:Optimized Defaults F7:Standard Defaults		

DTS Active Temperature:

This value controls the temperature of the ACPI Active Trip Point- the point in which the os will turn the CPU on.

NOTE: If the DTS is enabled, only values below 97°C are valid.

Passive Cooling Trip Point:

This value controls the temperature of the ACPI Active Trip Point- the point in which the os will begin throttling the CPU.

NOTE: If the DTS is enabled, only values below 97°C are valid.

Passive TC1 value:

This value sets the TC1 value for the ACPI passive cooling Formula.

Passive TSP Value:

This item sets the TSP value for the ACPI Passive cooling Formula. It represents in tenths of a second how often the os will read the temperature when Passive Cooling is Enabled.

Critical Trip Point:

This value controls the temperature of the ACPI critical Trip point—the point in which the OS will shut the system off.

NOTES: (1) 100°C is POP for all the Intel CPUs. (2) If value is >100°C and DTS is enabled, the Out-of-spec Bit will be used. (3) The value will be set to 127 after ACPI initialization.

Watchdog Timer Select

This item is used to activate the watchdog function. The optional settings are: Enabled; Disabled. When set it as Enabled user can choose configuration figures in sub items.

Watchdog Timer Value

This item is only activated when Watchdog Timer Select is set as Enabled and users can set a value from the range of 0~255

***Note: User needs an additional Watchdog Programming Reference Code to make use of this BIOS function. Detailed procedures please download from our website if necessary.**

3-6 PC Health Status

This section shows the Status of you CPU, Fan, and Warning for overall system status. This is only available if there is Hardware Monitor onboard.

Phoenix - AwardBIOS CMOS Setup Utility

PC Health Status

CPU FAN Configuration	Press Enter	Item Help
SYS FAN1 Configuration	Press Enter	
SYS FAN2 Configuration	Press Enter	Menu Level >
Shutdown Temperature	Disabled	
VCC 3.3	3.34V	
VSB	3.36V	
Voltage Battery	3.36V	
CPU Temp	42	
SYS Temp	47	
CPU Fan Speed	6482RPM	
SYS1 Fan Speed	0RPM	
SYS2 Fan Speed	0RPM	
↑↓←→ Move Enter:Select +/-/PU/PD:Value F10:Save ESC:Exit F1:General Help F5:Previous Values F6:Optimized Defaults F7:Standard Defaults		

CPU FAN Configurations

CPU Full-Speed Temp

This item allows you setting the FAN works in full speed when the temperature over the value which out set. If the temperature below the value but over the Idle Temperature, the FAN will works over 60% of full speed, and the higher temperature will gain higher FAN speed, after over the temperature which this item setting, the FAN works in full speed.

CPU Idle Temp

This item allows you setting the FAN works in 60% of full speed, when the temperature lower than the temperature which you setting.

3-7 Advanced Chipset Features

The Advanced Chipset Features Setup option is used to change the values of the chipset registers. These registers control most of the system options in the computer.

Phoenix - AwardBIOS CMOS Setup Utility

Advanced Chipset Features

System BIOS Cacheable	Enabled	M
Memory Hole At 15M-16M	Disabled	
Vt-d	Disabled	
VGA Setting		
On-chip Frame Buffer Size	32Mb	Menu Level >
DVMT Mode	Enabled	
Total GFX Memory	256MB	
PAVP Mode	PAVP-List	
VGA Boot Device Setting		
Boot Display	VBIOS Default	
Panel Scaling	Auto	
Panel Type	VBIOS Default	
TV1 Standard Type	VBIOS Default	
LVDS Switch	Default	
CPU Spread Support	Disabled	
Spread Mode	Down Spread	

↑↓→← Move Enter: Select +/-/PU/PD: Value F10:Save ESC: Exit F1:General Help
F5:Previous Values F6:Optimized Defaults F7:Standard Defaults

System BIOS Cacheable

Selecting Enabled allows caching of the system BIOS ROM at F0000h-FFFFFh, resulting in better system performance. However, if any program writes to this memory area, a system error may result. The settings are: Enabled and Disabled.

Total GFX Memory:

For WinXP, the MAX value is base on system memory size 512MB for 1GB DRAM, 768MB for 1.5GB to 2 GB, 1GB for above 2GB.

Boot Display:

Select the video Device that will be activated during POST.

3-8 Power Management Setup

The Power Management Setup allows you to configure your system to most effectively save energy saving while operating in a manner consistent with your own style of computer use.

Phoenix - AwardBIOS CMOS Setup Utility

Power Management Setup

PCI Express PM Function	Press Enter	Item Help
ACPI Suspend Type	S1(pos)	
Run VGABIOS if S3 Resume	Auto	Menu Level >
Power Management	USER Define	
Video off Method	DPMS	
Video off Suspend	Yes	
Suspend Type	Stop Grant	
MODEN USE IRQ	3	
Suspend Mode	Disabled	
Soft-off by PWR-BTTN	Instant-off	
Wake-up by PCI card	Disabled	
Power on by ring	Eabled	
USB KB Wake up from S3(S4)	Disabled	
Resume by Alarm	Disabled	
Date (of Month) Alarm	0	
Time (hh:mm:ss)Alarm	0:0:0	
HPET Support	Enabled	
HPET Mode	32-bit mde	
↑↓→← Move Enter:Select +/-/PU/PD:Value F10:Save ESC:Exit F1:General Help F5:Previous Values F6:Optimized Defaults F7:Standard Defaults		

ACPI Function

This item allows you to Enabled/Disabled the Advanced Configuration and Power Management (ACPI). The settings are Enabled and Disabled.

Video Off Method

This determines the manner in which the monitor is blanked.

DPMS (default) Initial display power management signaling.

Blank Screen This option only writes blanks to the video buffer.

V/H SYNC+Blank This selection will cause the system to turn off the vertical and horizontal synchronization ports and write blanks to the video buffer.

MODEM Use IRQ

If you want an incoming call on a modem to automatically resume the system from a power-saving mode, use this item to specify the interrupt request line (IRQ) that is used by the modem. You might have to connect the fax/modem to the motherboard Wake On Modem connector for this feature to work.

Soft-Off by PWRBTN

Under ACPI (Advanced Configuration and Power management Interface) you can create a software power down. In a software power down, the system can be resumed by Wake up Alarms. This item lets you install a software power down that is controlled by the power Button on your system. If the item is set to Instant-Off, then the power button causes a software power down. If the item is set to Delay 4 Sec, then you have to hold the power button down for four seconds to cause a software power down.

3-9 PnP/PCI Configuration

Phoenix - AwardBIOS CMOS Setup Utility

Pnp/PCI Configuration

Init Display First	PCI Slot	Item Help
Reset Configuration Data	Disabled	
Recourse Configuration By	Auto(ESD)	
IRQ Recourses	Press Enter	
PCI/VGA Palette Snoop	Disabled	Menu Level >
INT pin 1 Assignment	Auto	
INT pin 2 Assignment	Auto	
INT pin 3 Assignment	Auto	
INT pin 4 Assignment	Auto	
INT pin 5 Assignment	Auto	
INT pin 6 Assignment	Auto	
INT pin 7 Assignment	Auto	
INT pin 8 Assignment	Auto	
PCI Express relative items		
Maximum Payload size	128	

↑↓← Move Enter:Select +/-/PU/PD:Value F10:Save ESC:Exit F1:General Help
F5:Previous Values F6:Optimized Defaults F7:Standard Defaults